

BEAUDESERT & BOONAH CRANES

149 SANDY CREEK ROAD, BROMELTON QLD 4285

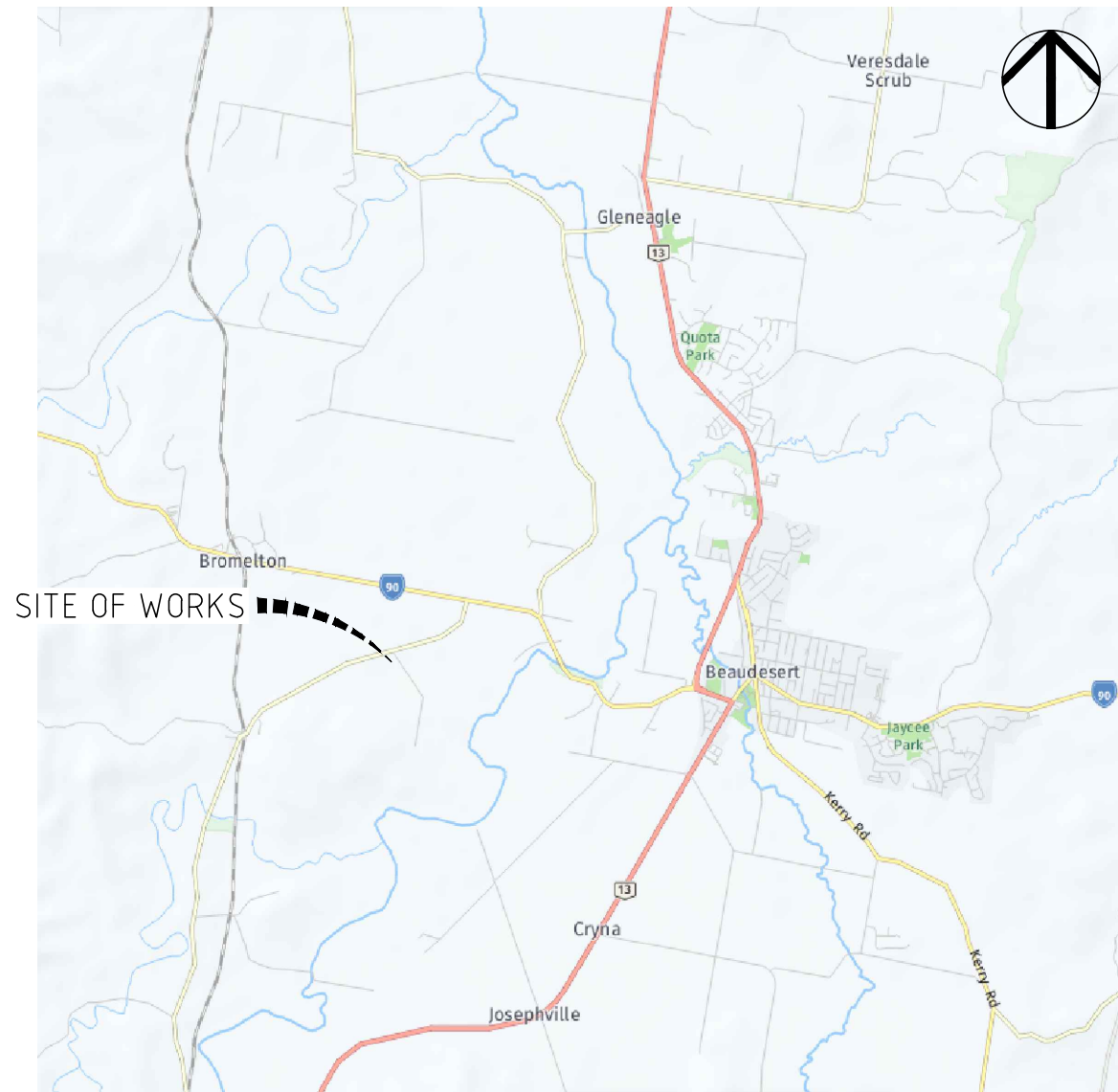

LOCALITY PLAN
N.T.S

SHEET NO.	SHEET TITLE	REVISION
01	COVER SHEET	6
02	GENERAL NOTES	4
03	CONCRETE NOTES	1
04	TYPICAL DETAILS	5
05	OVERALL LAYOUT PLAN	7
06	TURNING TEMPLATES	5
07	PROPERTY ACCESS LAYOUT PLAN	6
08	SIGHT DISTANCE ASSESSMENT	5
09	STORMWATER LAYOUT PLAN	5
10	BIO-DETENTION BASIN DETAILS	4
11	ESC NOTES - SHEET 01	4
12	ESC NOTES - SHEET 02	4
13	ESC NOTES - SHEET 03	4
14	ESC DETAILS	4
15	ESC LAYOUT PLAN	5
16	BUILDING LAYOUT PLAN	1

PLANS AND DOCUMENTS
referred to in the
SDA APPROVAL



SDA approval: AP2024/001

REVISION/DETAILS	DWN	DATE	DES	DATE	BEAUDESERT & BOONAH CRANES				COVER SHEET		P0 Box 554 Beaudesert QLD 4285 (07) 5541 3500 www.acsengineers.com.au		ACS Engineers CIVIL ENVIRONMENTAL PROJECT MANAGEMENT										
#	FIELD	NAME	SIGNATURE	DATE	BEAUDESERT & BOONAH CRANES		ENGINEERING CERTIFICATION (RPEQ)		DRAWING NUMBER		REVISION												
6	ACCESS LOCATION ADJUSTED AS PER RFI	NJF	30/01/25		SURVEY DATA		BEAUDESERT & BOONAH CRANES		#		FIELD		NAME		SIGNATURE		DATE		DRAWING NUMBER		REVISION		
5	CONCRETE ACCESS UPDATES	NJF	18/11/24		DATUM		48 KOOROOMBA DRIVE, MT ALFORD QLD 4310		13697		CIVIL		S. SHAY				30/01/25		ACS-230068-GEN-01		6		
4	INCLUSION OF NOTES FOR PROPERTY ACCESS	MLS	11/06/24		MAP GRID																		
3	INCLUSION OF VEGETATION BUFFER, RELOCATED DRAIN	MLS	22/04/24		HEIGHT ORIGIN																		
2	FOR APPROVAL	NJF	10/04/24		SURVEY BOOKS																		
1	PRELIMINARY	NJF	28/09/23				149 SANDY CREEK ROAD, BROMELTON QLD 4285																
<small>FILE: C:\1205\DATA\ACSS\YN\230068 BEAUDESERT & BOONAH CRANES - 149 SANDY CREEK ROAD, BROMELTON_681\DESIGN\DRAWING FILES\ACS-230068-GEN.DWG PLOT TIME: 30/12/2025 - 8:18AM BY USER: NICHOLASFALVEY</small>																							

GENERAL NOTES

1. THE BILL OF QUANTITIES (BOQ) IS PROVIDED AS A GUIDE ONLY. THE CONTRACTOR IS TO REVIEW THIS BOQ AGAINST THE PLANS AND VERIFY QUANTITIES AS A PART OF THEIR DUE DILIGENCE IN TENDERING. ANY DISCREPANCIES ARE TO BE REFERRED TO ACS ENGINEERS FOR CLARIFICATION.
2. THE CONTRACTOR IS RESPONSIBLE FOR ACCURATELY ASCERTAINING THE LOCATION OF EXISTING UNDERGROUND AND OVERHEAD SERVICES PRIOR TO THE COMMENCEMENT OF WORKS.
3. REFER ANY DISCREPANCY TO THE PRINCIPLE ENGINEER BEFORE PROCEEDING WITH THE WORK.
4. PRIOR TO CONSTRUCTION LOCATE ALL EXISTING SERVICES IN THE VICINITY THAT MAY BE AFFECTED BY THE PROPOSED CONSTRUCTION.
5. DESIGN LEVELS TO BE CONFIRMED ON SITE PRIOR TO COMMENCING CONSTRUCTION.
6. CONCRETE ELEMENTS INCLUDING KERBS, FOOTPATHS, DRIVEWAYS ETC. SHALL BE SAW CUT WHERE REQUIRED AND SHALL BE REPLACED WITH MATCHING SURFACE TEXTURE AND TREATMENT AS ADJOINING SURFACES OR AS SPECIFIED IN THE DRAWINGS. NEW SURFACE SHALL MATCH SMOOTHLY WITH ADJOINING SURFACES.

SURVEY:

1. THE DATUM FOR ALL LEVELS IS THE AUSTRALIAN HEIGHT DATUM IN METRES AND PROJECTIONS ARE BASED ON MGA 94 ZONE 56 COORDINATE SYSTEM.
2. THE ACCURACY OF PROPERTY BOUNDARIES IS NOT TO BE RELIED UPON AND SHOULD BE VERIFIED BY THE SURVEYOR.
3. SOME SERVICES HAVE BEEN EXPOSED AND LOCATED BUT OTHER SERVICE POSITIONS ARE DERIVED FROM SURFACE FEATURES ONLY. PRIOR TO EXCAVATION THE RELEVANT AUTHORITY SHOULD BE CONTACTED FOR DETAILED LOCATION OF ALL SERVICES.

SITE ACCESS:

1. PRIOR TO THE COMMENCEMENT OF SITE WORKS, THE LOCATION OF THE SITE ACCESS POINT MUST BE VERIFIED WITH RELEVANT AUTHORITY.
2. SITE ACCESS IS RESTRICTED TO ONE LOCATION.
3. SITE EXIT POINT MUST BE APPROPRIATELY MANAGED TO MINIMISE THE RISK OF SEDIMENT BEING TRACKED ONTO SEALED PUBLIC ROADWAYS.
4. STORMWATER RUNOFF FROM ACCESS ROADS AND STABILISED ENTRY/EXIT POINTS MUST DRAIN TO AN APPROPRIATE SEDIMENT CONTROL DEVICE.

EARTHWORKS - GENERAL

1. THE CONTRACTOR IS TO STRIP THE CONSTRUCTION AREA OF ALL GRASS, SHRUBS, RUBBISH, DELETERIOUS MATERIAL AND UNSUITABLE TOPSOIL AS NOMINATED BY THE ENGINEER.
2. DISPOSAL OF UNSUITABLE MATERIAL IS TO BE ONSITE. TOPSOIL APPROVED BY THE CLIENT FOR REUSE, IS TO BE STOCKPILED ON SITE AS DIRECTED.
3. BULK EARTHWORKS IS TO BE CARRIED OUT IN ACCORDANCE WITH COUNCIL STANDARDS AND THE REQUIREMENTS OF AS3798.
4. ALL FILL UNDER FOOTINGS AND SLABS SHALL BE COMPACTED IN LAYERS NOT GREATER THAN 200mm TO 98% STANDARD COMPACTION FOR COHESIVE MATERIALS OR A DENSITY INDEX OF NOT LESS THAN 70% FOR NON COHESIVE MATERIALS.
5. ALL EARTHWORKS ARE TO BE UNDERTAKEN UNDER THE LEVEL 1 INSPECTION AND TESTING REQUIREMENTS OUTLINED IN AS3798.
6. THE CONTRACTOR SHALL PROVIDE DETAILS OF ALL TESTING TO THE SUPERVISING ENGINEER PROGRESSIVELY THROUGH THE WORKS AND NOTIFY THE ENGINEER OF ANY NON-CONFORMANCES. ALL NON CONFORMING WORK IS TO BE RECTIFIED.
7. PRIOR TO WORKS PROCEEDING, REMOVE SOFT AND OR COMPRESSIBLE ZONES AND REPLACE WITH SELECT SITE MATERIAL COMPACTED TO A DENSITY CONSISTENT WITH THAT NOTED FOR THE PROPOSED FILLING.
8. IT IS THE CONTRACTORS RESPONSIBILITY TO PROTECT THE SITE AND SURROUNDING AREAS FROM DAMAGE RESULTING FROM STORMWATER RUNOFF. TEMPORARY DIVERSION DRAINS AND OR OTHER DRAINAGE CONTROL DEVICES ARE TO BE IMPLEMENTED BY THE CONTRACTOR DURING CONSTRUCTION TO MINIMISE THE EFFECTS OF WEATHER.
9. ALL FILL MATERIAL PLACED ON THE SITE COMPRISING ONLY NATURAL EARTH AND ROCK IS TO BE FREE OF CONTAMINANTS (AS DEFINED BY SECTION 11 OF THE ENVIRONMENTAL PROTECTION ACT (EPA) 1994), NOXIOUS, HAZARDOUS, DELETERIOUS AND ORGANIC MATERIALS.
10. IMPORTED FILL FOR BUILDING PAD SHALL MEET THE REQUIREMENTS OF AS3798 FOR IMPORTED FILL.
11. BUILDING PAD TO BE KEYED INTO NATURAL SURFACE AFTER TOPSOIL STRIP.

EARTHWORKS - ROADWAYS

1. CLEARING AND GRUBBING SHALL BE LIMITED TO THOSE AREAS REQUIRED TO CONSTRUCT THE WORKS AND/OR MEET VISIBILITY REQUIREMENTS.
2. CLEARED AND GRUBBED MATERIAL OTHER THAN THAT MULCHED SHALL BE REMOVED FROM THE SITE AND DISPOSED OF IN ACCORDANCE WITH ALL RELEVANT STATUTORY REQUIREMENTS.
3. WHERE WHEREVER PRACTICAL TOPSOIL SHALL BE TRANSFERRED DIRECTLY TO PLACEMENT AS PLANTING MEDIA. WHERE STOCKPILING OF TOPSOIL IS REQUIRED, IT SHALL BE CARRIED OUT IN A MANNER WHICH ENSURES THE PROPERTIES OF THE TOPSOIL ARE NOT PERMITTED TO DEGRADE SUCH THAT IT BECOMES UNSUITABLE AS PLANTING MEDIA.
4. WHERE UNSUITABLE MATERIAL IS ENCOUNTERED ONSITE, THE FOREMAN SHALL NOTIFY THE PROJECT ENGINEER BEFORE PROCEEDING TO REMOVE OR COVER SUCH MATERIAL.
5. MATERIAL USED FOR CONSTRUCTION OF SUBGRADE IN ROAD EMBANKMENT, WHERE DIRECTED, SHALL BE GENERAL FILL MATERIAL SUITABLE FOR PLACEMENT USING THE COMPACTED LAYER METHOD AND HAS A MAXIMUM STONE SIZE OF 75mm.

EXCAVATION ADJACENT TO POWER POLES:

1. POSSIBLE TRENCH SHORING REQUIREMENTS NEAR POWER POLES TO BE COORDINATED WITH ENERGEX AND THE APPROPRIATE APPROVALS TO BE OBTAINED FROM ENERGEX PRIOR TO CONSTRUCTION COMMENCEMENT.
2. ANY TRENCHING REQUIREMENTS ADJACENT TO EXISTING POWER POLES SHALL HAVE THE POWER POLES ADEQUATELY SUPPORTED DURING TRENCHING AND BACKFILLING OPERATIONS. A CERTIFIED ENGINEERING ASSESSMENT OF THE COMPACTION OF BACKFILL MATERIAL IS TO BE PROVIDED TO AND ASSESSED BY ENERGEX TO ENSURE POLE STABILITY BEFORE REMOVAL OF ADDITIONAL SUPPORT.
3. ALL CONSTRUCTION WITHIN 3m OF OVERHEAD POWER LINES REQUIRE 'SAFETY ADVICE ON WORKING AROUND ELECTRICAL POSTS' FORM BS00014.05F108 FROM ENERGEX.

CONSTRUCTION NOTES

1. THESE DRAWINGS SHALL BE READ IN CONJUNCTION WITH ALL ENGINEERS AND OTHER CONSULTANT'S DRAWINGS AND SPECIFICATIONS AND WITH OTHER SUCH WRITTEN INSTRUCTIONS AS MAY BE ISSUED DURING THE COURSE OF THE CONTRACT. ANY DISCREPANCIES SHALL BE REFERRED TO THE ENGINEER BEFORE PROCEEDING WITH THE WORK.
2. NO RESPONSIBILITY WILL BE TAKEN FOR DIMENSIONS OBTAINED BY SCALING THESE DRAWINGS.
3. ALL DIMENSIONS SHALL BE VERIFIED ON SITE BY THE CONTRACTOR WHO SHALL BE RESPONSIBLE FOR THEIR CORRECTNESS.
4. THE CONTRACTOR SHALL BE RESPONSIBLE FOR MAINTAINING THE STRUCTURE AND NEIGHBOURING STRUCTURES IN A SAFE AND STABLE CONDITION DURING CONSTRUCTION. NO PART SHALL BE OVER STRESSED.
5. ALL WORKMANSHIP AND MATERIALS SHALL BE IN ACCORDANCE WITH THE REQUIREMENTS OF THE CURRENT S.R.R.C SPECS AND THE BY-LAWS AND ORDINANCES OF THE RELEVANT GOVERNMENT AUTHORITY.
6. THE CONTRACTOR SHALL PROVIDE TRAFFIC MANAGEMENT FOR THE DURATION OF CONSTRUCTION IN ACCORDANCE WITH "THE MANUAL OF UNIFORM TRAFFIC CONTROL DEVICES - PART 3 2017", IF REQUIRED.
7. THE CONTRACTOR IS TO LOCATE, IDENTIFY AND ESTABLISH THE CONNECTIVITY OF ALL EXISTING SERVICES WITHIN THE LIMITS OF THE WORKS AND CONFIRM THIS INFORMATION WITH THE ENGINEER PRIOR TO THE COMMENCEMENT OF WORK.
8. PROPERTY BOUNDARIES ARE SUBJECT TO CONFIRMATION BY FIELD SURVEY CARRIED OUT BY A REGISTERED SURVEYOR.
9. ALL WORK SHALL BE JOINED NEATLY TO EXISTING FEATURES.
10. THE CONTRACTOR SHALL BE RESPONSIBLE FOR PROVIDING ALL MEASURING DEVICES, SAFETY EQUIPMENT AND MACHINERY REQUIRED TO CARRY OUT INSPECTIONS AS SPECIFIED OR REQUESTED.
11. THE CONTRACTOR SHALL RESTORE ALL EXTERNAL AREAS TO THE SITE, TO THEIR ORIGINAL CONDITION UPON COMPLETION OF THE WORKS.

PAVEMENT NOTES:

1. BASE GRAVEL TO BE TYPE 2 MATERIAL WITH MINIMUM CBR80 AND SUB-BASE GRAVEL TO BE TYPE 2 MATERIAL WITH MINIMUM CBR45 IN ACCORDANCE WITH MAIN ROADS SPECIFICATION MRTS05 UNBOUND PAVEMENTS.
2. COMPACTION STANDARD OF SUB-BASE & BASE PAVEMENTS SHALL ACHIEVE A CHARACTERISTIC VALUE OF THE RELATIVE DRY DENSITY NOT LESS THAN 100%.
3. THE PAVEMENT SHALL BE CONSTRUCTED SO AS NOT TO DEPART FROM THE WIDTHS, LENGTHS, HEIGHTS AND SHAPES SPECIFIED IN THESE PLANS UNLESS AUTHORISED BY PROJECT ENGINEER. THE WIDTHS, HEIGHTS AND SHAPES OF LAYERS OTHER THAN THE FINAL LAYER SHALL BE CALCULATED USING THE COMPLETED PAVEMENT SURFACE AND THE DEPTH TO SURFACE OF THE PARTICULAR LAYER WITHIN THE PAVEMENT.
4. COMPACTED LAYER THICKNESS SHALL NOT BE GREATER THAN 200mm OR LESS THAN 100mm.
5. ROAD SURFACE TO BE CLEAN AND DRY PRIOR TO PLACING SEAL.
6. SEAL TO CONSIST OF TWO COATS C170 BITUMEN WITH 14mm COVER AGGREGATE APPLIED TO FIRST COAT AND 7mm COVER AGGREGATE TO SECOND COAT. SPRAY RATES AND AGGREGATE SPREAD RATES TO BE CONFIRMED BY PROJECT ENGINEER.

DELINEATION:

1. WHERE PAVEMENT IS 6.8m WIDE OR GREATER, GUIDE POSTS SHALL BE USED ON UNDIVIDED RURAL ROADS AT, OR NEAR, THE EDGE OF FORMATION AND AT A CONSTANT DISTANCE (GENERALLY BETWEEN 1.2m AND 3.0m) FROM THE PAVEMENT EDGE.
2. NOMINAL SPACING OF GUIDE POSTS ON A STRAIGHT SECTION OF ROAD SHALL BE 150m, WITH THE POSTS IN PAIRS, ONE EACH SIDE OF THE FORMATION. THE SPACING MAY BE REDUCED TO 75M IN AREAS SUBJECT TO FREQUENT FOGS.
3. THE SPACING OF GUIDE POSTS ON CURVES SHALL BE AS GIVEN IN THE TABLE 4.1 ON THIS SHEET.

ENVIRONMENTAL:

1. THE EXTENT OF CLEARING OF VEGETATION SHALL BE KEPT TO THE ABSOLUTE MINIMUM NECESSARY TO UNDERTAKE THE WORKS.
2. SILTATION CONTROLS, SITE REVEGETATION AND ENVIRONMENTAL REQUIREMENTS SHALL BE CARRIED OUT TO THE SATISFACTION OF THE PRINCIPAL.

OTHER:

1. THE CONTRACTOR IS TO TAKE ALL NECESSARY PRECAUTIONS TO CONTROL EROSION AND DOWNSTREAM SEDIMENTATION DURING ALL STAGES OF CONSTRUCTION INCLUDING THE MAINTENANCE PERIOD.
2. ALL SEDIMENT CONTROL DEVICES SHALL BE MONITORED, CLEANED AND/OR REPAIRED WHENEVER THE ACCUMULATED SEDIMENT REDUCES THE CAPACITY BY 50%.
3. THE EXTENT OF GRASSING SHALL BE DETERMINED BY THE SUPERINTENDENT AND SHALL BE SEEDED, AS SPECIFIED, WITHIN SEVEN DAYS OF FINAL TRIMMING.
4. EXTENT AND POSITION OF SILT FENCE CONTROL MEASURES TO BE DETERMINED ON SITE BY SUPERINTENDENT.
5. MEASURES SHOWN ON THIS DRAWING ARE MINIMUM REQUIREMENTS ONLY.
6. SCOUR PROTECTION AND SILT MANAGEMENT MEASURES TO BE PROVIDED AT STORMWATER OUTLET HEADWALLS.
7. PROVISION TO BE MADE FOR DIRT/SAND REMOVAL FROM CONSTRUCTION VEHICLES PRIOR TO TRAVEL ON PUBLIC ROADS. METHOD TO BE APPROVED BY SUPERINTENDENT PRIOR TO COMMENCEMENT OF WORK.
8. ANY SILT OR SEDIMENT CAUSED BY CONSTRUCTION TRAFFIC ON EXISTING ROADS IS TO BE REMOVED DAILY.
9. THE CONTRACTOR SHALL IMPLEMENT EROSION AND SEDIMENT CONTROL PROCEDURES DURING CONSTRUCTION AND MAINTENANCE STAGES OF THE DEVELOPMENT AND SHALL TAKE ALL NECESSARY ACTIONS TO COMPLY WITH THE POLICY OBJECTIVES OF COUNCIL'S LOCAL PLANNING POLICY - EROSION AND SEDIMENT CONTROL.
10. A SCHEDULE SHALL BE SUBMITTED FOR THE APPROVAL OF COUNCIL'S REPRESENTATIVE AT THE PRE-START MEETING FOR THE FIELD IMPLEMENTATION OF EROSION AND SEDIMENT CONTROL, DETAILING THE STAGES AT WHICH VARIOUS MANAGEMENT TECHNIQUES WOULD BE IN PLACE AND AUDITING PROCEDURES.
11. FINAL FORM OF SEDIMENT EROSION CONTROL TO BE DECIDED ON SITE BY THE SUPERINTENDENT.
12. THE CONTRACTOR IS TO ENSURE THAT NO SILT REACHES THE DOWNSTREAM WATER COURSE AND IS TO PROVIDE ADEQUATE PROTECTION TO PREVENT THIS OCCURRING.

PLANS AND DOCUMENTS referred to in the SDA APPROVAL



SDA approval: AP2024/001

		SURVEY DATA		BEAUDESERT & BOONAH CRANES		GENERAL NOTES		P.O. Box 554 Beaudesert QLD 4285		 CIVIL ENVIRONMENTAL PROJECT MANAGEMENT		
		DATUM		48 KOOROomba DRIVE, MT ALFORD QLD 4310								
4	INCLUSION OF NOTES FOR PROPERTY ACCESS	MLS	11/06/24	MAP GRID				(07) 5541 3500 www.acsengineers.com.au		DRAWING NUMBER		
3	INCLUSION OF VEGETATION BUFFER, RELOCATED DRAIN	MLS	22/04/24	HEIGHT ORIGIN						REVISION		
2	FOR APPROVAL	NJF	10/04/24	SURVEY BOOKS								
1	PRELIMINARY	NJF	28/09/23									
REVISION/DETAILS		DWN	DATE	DES	DATE							
				149 SANDY CREEK ROAD, BROMELTON QLD 4285		#	FIELD	NAME	SIGNATURE	DATE	ACS-230068-GEN-02	
						13697	CIVIL	S. SHAY		30/01/25	4	

NOTES

- SUBGRADE TO BE PROOF ROLLED BEFORE PLACEMENT OF GRAVEL.
- DIMENSIONS ARE IN MILLIMETRES UNLESS SHOWN OTHERWISE.
- GRAVEL SUB-BASE. 200mm CBR 80 2% CEMENT U.N.O.
- THICKNESS OF CONCRETE IS STRUCTURAL THICKNESS. ALL CONCRETE FINISHES SHALL BE ALLOWED FOR ADDITIONAL eg. DEPTH OF CONCRETE STAMPING.
- JOINTS TO BE PLACED AT MAXIMUM SPACINGS UNLESS NOTED OTHERWISE.
- CONCRETE, APART FROM SMOOTH TROWLED JOINTS AND EDGE TREATMENTS TO HAVE BROOM FINISH.

CONCRETE NOTES (ROADS)

- ALL WORKMANSHIP AND MATERIALS SHALL BE IN ACCORDANCE WITH AS.3600, CURRENT EDITION WITH AMENDMENTS.

- CONCRETE QUALITY (UNLESS SHOWN OTHERWISE):
 CEMENT SHALL BE TYPE 'A' NORMAL PORTLAND CEMENT.
 MAXIMUM SIZE OF COARSE AGGREGATE SHALL BE 20 mm.
 CONCRETE SHALL HAVE THE FOLLOWING SLUMP DURING PLACING:
 - BEAMS, SLABS AND FOOTINGS 80 mm.
 - COLUMNS AND WALLS 80 mm.

ADMIXTURES SHALL NOT BE USED WITHOUT THE WRITTEN APPROVAL OF THE ENGINEER.

ELEMENT	ROAD
CONCRETE STRENGTH	N32
SPECIAL REQUIREMENTS	NIL

STRENGTH SHALL BE VERIFIED BY PROJECT CONTROL TESTING.

- CLEAR CONCRETE COVER TO REINFORCEMENT INCLUDING TIES AND STIRRUPS, UNLESS SHOWN OTHERWISE, SHALL BE:

ELEMENT	SLABS
FORMED & SHELTERED	30mm
FORMED & EXPOSED	40mm
NO FORMWORK	40mm

COVER TO REINFORCEMENT SHALL BE OBTAINED BY THE USE OF PLASTIC BAR CHAIRS. ALL CHAIRS SHALL BE SPACED AT MAXIMUM 800mm CENTRES EACH WAY.

- REINFORCEMENT SYMBOLS:
 "S" :GRADE 230S HOT ROLLED DEFORMED BAR TO AS.1302
 "Y" :GRADE 410Y HOT ROLLED DEFORMED BAR TO AS.1302
 "R" :GRADE 230R HOT ROLLED PLAIN BAR TO AS.1303
 "W" :HARD DRAWN PLAIN WIRE TO AS.1303

- REINFORCEMENT IS REPRESENTED DIAGRAMMATICALLY AND IS NOT NECESSARILY SHOWN IN TRUE PROJECTION.

- WELDING OF THE REINFORCEMENT WILL NOT BE PERMITTED UNLESS SHOWN ON THE STRUCTURAL DRAWINGS.

7. FABRIC LAP DETAIL:

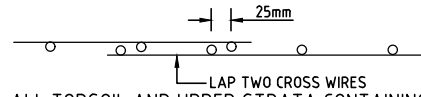

- ALL TOPSOIL AND UPPER STRATA CONTAINING ORGANIC MATTER SHALL BE REMOVED AND REPLACED BY APPROVED FILLING MATERIAL COMPACTED IN LAYERS NOT GREATER THAN 150mm TO MINIMUM 95% STANDARD COMPACTION.

- CONCRETE SIZES SHOWN ARE MINIMUM AND NO REDUCTIONS BY DUCTS, PIPES, ETC., SHALL BE MADE WITHOUT THE APPROVAL OF THE SUPERVISING OFFICER. SIZES DO NOT INCLUDE THICKNESS OF APPLIED FINISHES.

- TRIM ALL PENETRATION WITH 2/Y12 BARS EACH SIDE AND DISPLACE REINFORCEMENT EITHER SIDE. U.N.O.

- PIPES OR CONDUITS SHALL NOT BE PLACED WITHIN THE CONCRETE COVER TO REINFORCEMENT WITHOUT THE APPROVAL OF THE ENGINEER.

- ALL CONCRETE SHALL BE VIBRATED USING HIGH FREQUENCY VIBRATORS.

- CURINGS OF ALL CONCRETE SURFACES SHALL COMMENCE IMMEDIATELY AFTER SURFACES ARE FINISHED AS SPECIFIED AND SHALL CONTINUE FOR A MINIMUM OF 7 DAYS.

- SLABS WITH SPECIFIED ROUGH FINISH ARE TO BE KEPT FREE OF BLEED WATER AND FLOATED TO PREVENT THE FORMATION OF PLASTIC SHRINKAGE CRACKS.

- AN ALIPHATIC ALCOHOL EVAPORATION RETARDANT SHALL BE USED ON ALL SLABS IMMEDIATELY AFTER FIRST SCREED IN ACCORDANCE WITH THE MANUFACTURERS SPECIFICATIONS. AN ALIPHATIC ALCOHOL SHALL BE USED TO AID THE FINISHING OF THE CONCRETE SURFACE, WATER SHALL NOT BE USED.

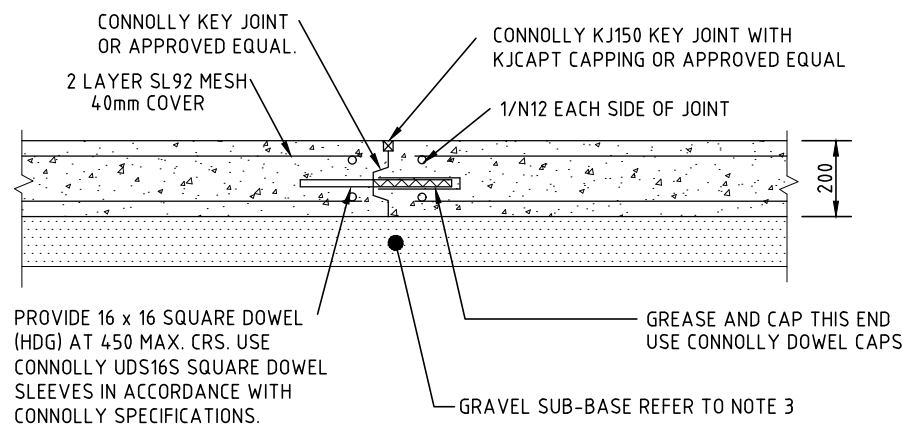

PROVIDE 16 x 16 SQUARE DOWEL (HDG) AT 450 MAX. CRS. USE CONNOLLY UDS16S SQUARE DOWEL SLEEVES IN ACCORDANCE WITH CONNOLLY SPECIFICATIONS.

GREASE AND CAP THIS END USE CONNOLLY DOWEL CAPS.

GRAVEL SUB-BASE REFER TO NOTE 3

DOWEL KEY JOINT (D.K.J.)

SPACING 8.0m
SCALE 1:20

- CONNOLLY SQUARE DOWEL TO BE PLACED IN ACCORDANCE WITH CONNOLLY SPECIFICATIONS, TYPICAL.

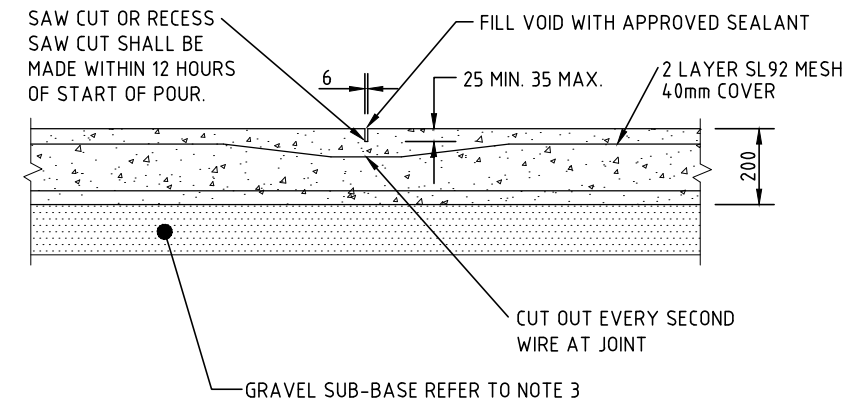

SAW CUT OR RECESS
SAW CUT SHALL BE MADE WITHIN 12 HOURS OF START OF POUR.

FILL VOID WITH APPROVED SEALANT

25 MIN. 35 MAX.

2 LAYER SL92 MESH 4.0mm COVER

CUT OUT EVERY SECOND WIRE AT JOINT

GRAVEL SUB-BASE REFER TO NOTE 3

SAWN JOINT (S.J.)

SPACING 4.0m
SCALE 1:20

JOINT SEALANTS
 ALL SLAB SEALANTS SHALL BE SIKAFLEX PRO 2HP POLYURETHANE JOINT SEALANT OR APPROVED EQUIVALENT.
 SEALANT MUST BE APPLIED STRICTLY TO MANUFACTURER'S SPECIFICATIONS WITH REGARD TO JOINT CONFIGURATION, SURFACE PREPARATION, PRIMING, DEBONDING, APPLICATION AND CLEANING.

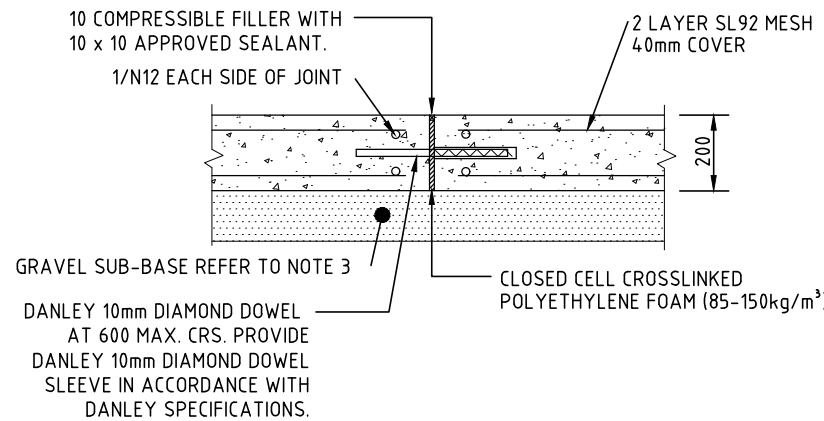

10 COMPRESSIBLE FILLER WITH 10 x 10 APPROVED SEALANT.

2 LAYER SL92 MESH 4.0mm COVER

1/N12 EACH SIDE OF JOINT

GRAVEL SUB-BASE REFER TO NOTE 3

DANLEY 10mm DIAMOND DOWEL AT 600 MAX. CRS. PROVIDE DANLEY 10mm DIAMOND DOWEL SLEEVE IN ACCORDANCE WITH DANLEY SPECIFICATIONS.

CLOSED CELL CROSSLINKED POLYETHYLENE FOAM (85-150kg/m³)

EXPANSION DOWEL JOINT (E.D.J.)

SPACING 24m
SCALE 1:20

- DANLEY DIAMOND DOWEL TO BE PLACED IN ACCORDANCE WITH DANLEY SPECIFICATIONS, TYPICAL.
- PROVIDE 24 HOUR MINIMUM BETWEEN ADJACENT POUR BREAKS, TYPICAL.

PLANS AND DOCUMENTS referred to in the SDA APPROVAL



SDA approval: AP2024/001

		SURVEY DATA		BEAUDESERT & BOONAH CRANES		CONCRETE NOTES			P0 Box 554 Beaudesert QLD 4285 (07) 554 13500 www.acsengineers.com.au		ACS Engineers CIVIL ENVIRONMENTAL PROJECT MANAGEMENT	
		DATUM		48 KOOROomba DRIVE, MT ALFORD QLD 4310					DRAWING NUMBER		REVISION	
		MAP GRID							ACS-230068-GEN-03		1	
		HEIGHT ORIGIN		BEAUDESERT & BOONAH CRANES								
		SURVEY BOOKS										
1	CONCRETE DETAILS INCLUDED	MLS	18/11/24	149 SANDY CREEK ROAD, BROMELTON QLD 4285		#	FIELD	NAME	SIGNATURE	DATE		
						13697	CIVIL	S. SHAY	<i>S. Shay</i>	30/01/25		
REVISION/DETAILS		DWN	DATE	DES	DATE							

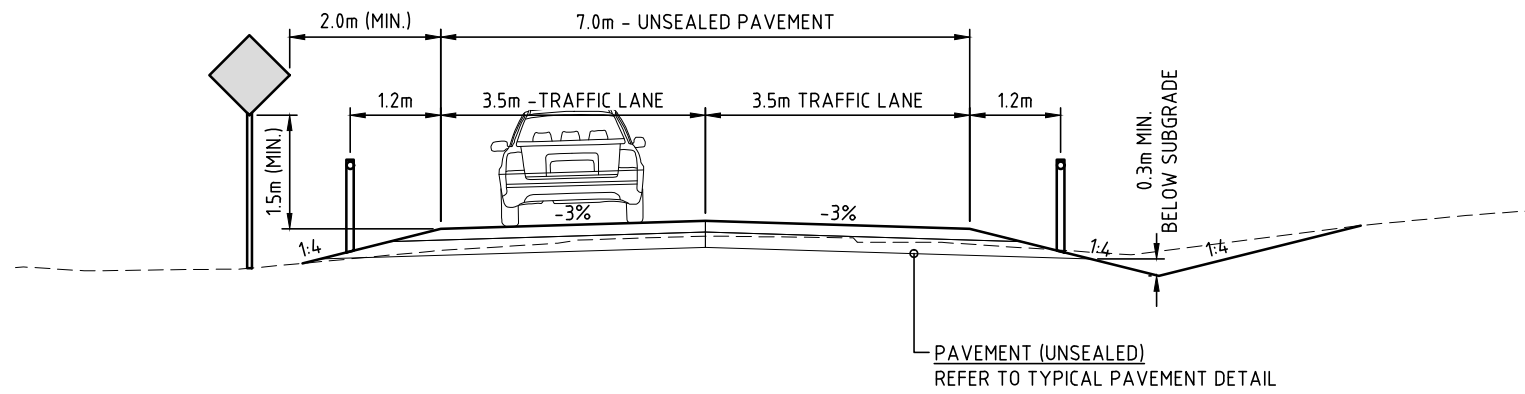

TYPICAL CROSS SECTION - INTERNAL ACCESS ROADS

SCALE 1:100
CLASS 5A

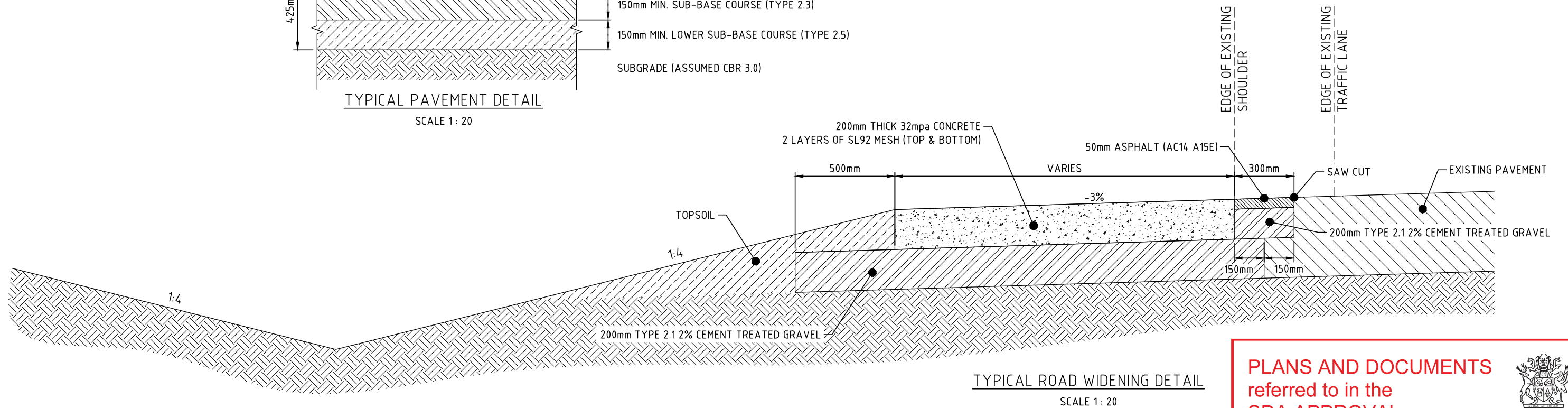
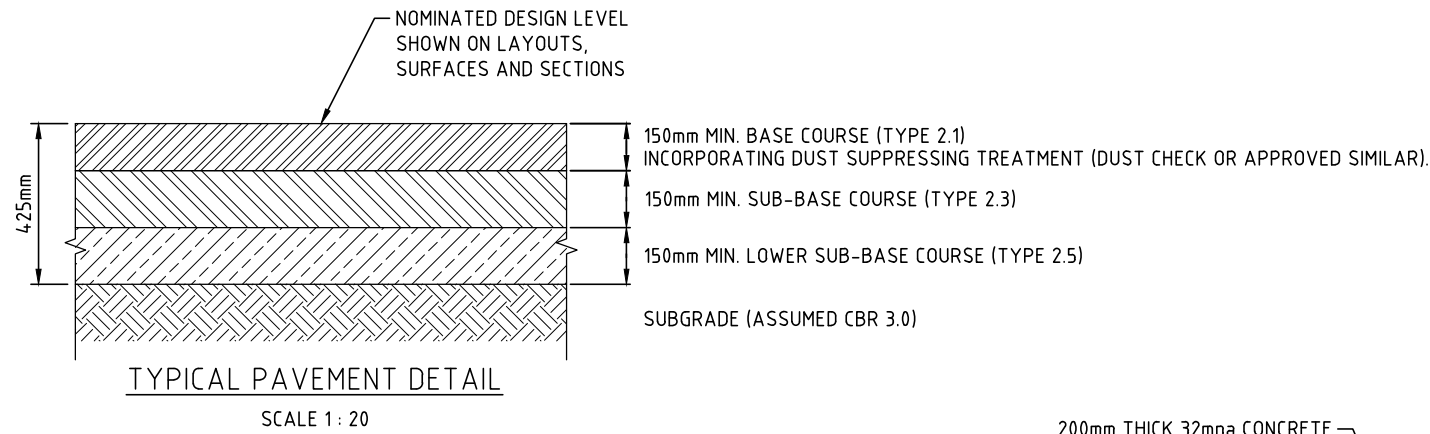
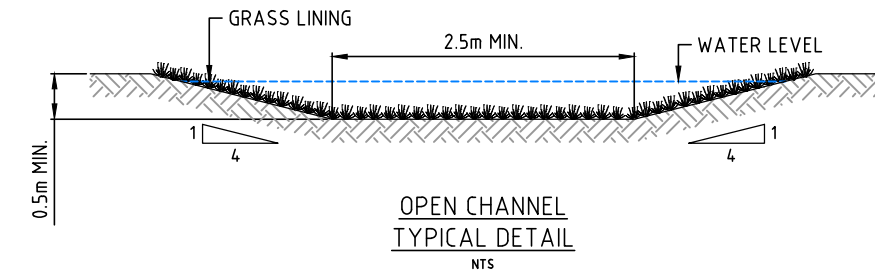

PLANS AND DOCUMENTS referred to in the SDA APPROVAL

SDA approval: AP2024/001



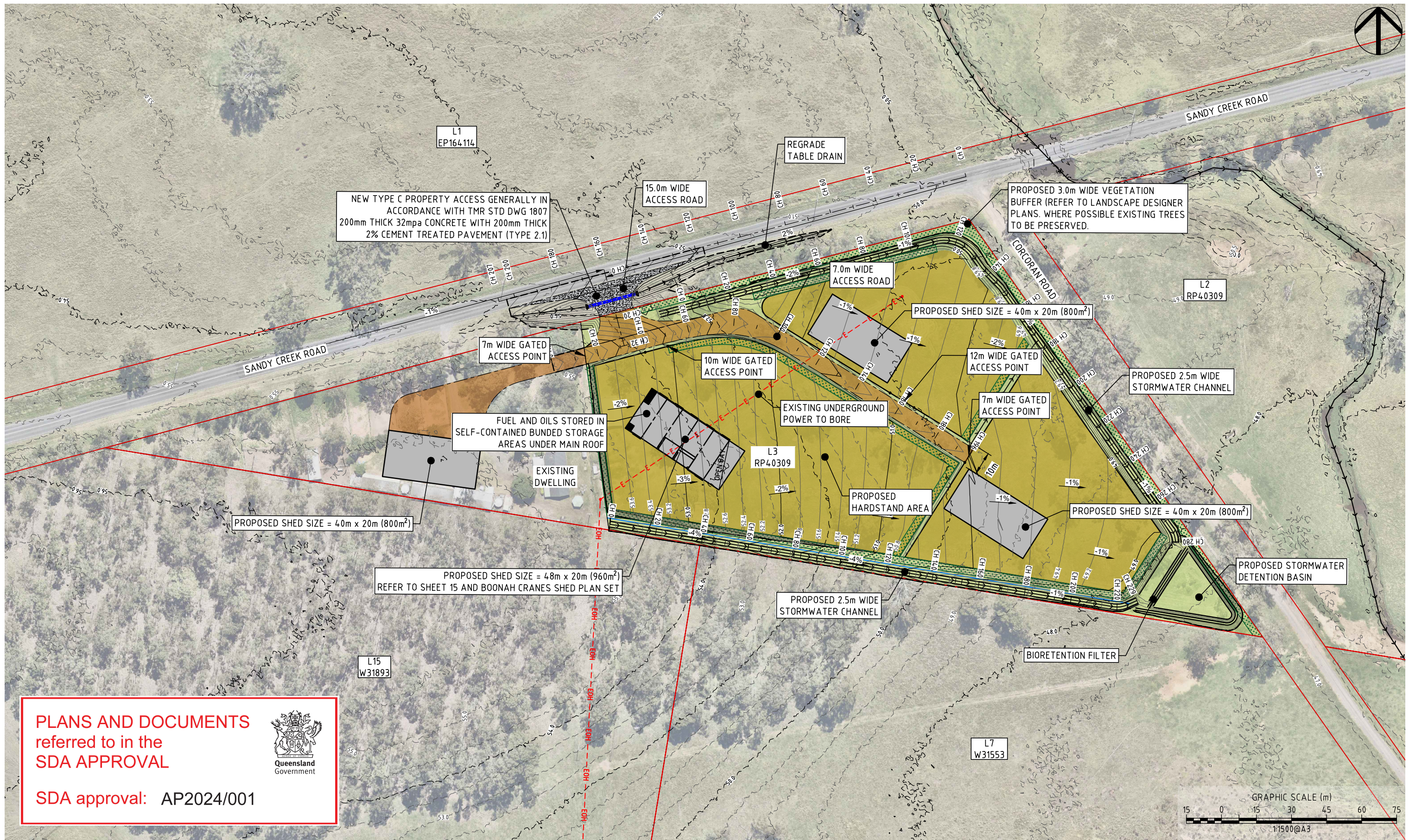

REVISION/DETAILS		DWN	DATE	DES	DATE	SURVEY DATA			BEAUDESERT & BOONAH CRANES		TYPICAL DETAILS			P0 Box 554 Beaudesert QLD 4285 (07) 5541 3500 www.acsengineers.com.au		ACS Engineers CIVIL ENVIRONMENTAL PROJECT MANAGEMENT			
5	UPDATES TO TYPICAL SECTIONS (CONCRETE ACCESS)	NJF	18/11/24	DATUM		BEAUDESERT & BOONAH CRANES			48 KOOROOMBA DRIVE, MT ALFORD QLD 4310			ENGINEERING CERTIFICATION (RPEQ)			DRAWING NUMBER		REVISION		
4	INCLUSION OF NOTES FOR PROPERTY ACCESS	MLS	11/06/24	MAP GRID		BEAUDESERT & BOONAH CRANES			149 SANDY CREEK ROAD, BROMELTON QLD 4285			#	FIELD	NAME	SIGNATURE	DATE	ACS-230068-GEN-04		5
3	INCLUSION OF VEGETATION BUFFER, RELOCATED DRAIN	MLS	22/04/24	HEIGHT ORIGIN								13697	CIVIL	S. SHAY		30/01/25			
2	FOR APPROVAL	NJF	10/04/24	SURVEY BOOKS															
1	PRELIMINARY	NJF	28/09/23																



PLANS AND DOCUMENTS referred to in the SDA APPROVAL

SDA approval: AP2024/001



7	ACCESS LOCATION ADJUSTED AS PER RFI	NJF	30/01/25	SURVEY DATA	BEAUDESERT & BOONAH CRANES	48 KOOROOMBA DRIVE, MT ALFORD QLD 4310	OVERALL LAYOUT PLAN	P0 Box 554 Beaudesert QLD 4285 (07) 5541 3500 www.acsengineers.com.au	ACS Engineers CIVIL ENVIRONMENTAL PROJECT MANAGEMENT	DRAWING NUMBER	REVISION	
6	CONCRETE NOTES INCLUDED	MLS	18/11/24									DATUM
5	LEASE LOT 1 SHED SIZE INCREASED. ADDITIONAL NOTES	NJF	21/10/24									MAP GRID
4	INCLUSION OF NOTES FOR PROPERTY ACCESS	MLS	11/06/24									HEIGHT ORIGIN
3	INCLUSION OF VEGETATION BUFFER, RELOCATED DRAIN	MLS	22/04/24	SURVEY BOOKS	BEAUDESERT & BOONAH CRANES	13697	CIVIL	S. SHAY		30/01/25	ACS-230068-GEN-05	7
2	FOR APPROVAL	NJF	10/04/24		149 SANDY CREEK ROAD, BROMELTON QLD 4285							
1	PRELIMINARY	NJF	28/09/23									
REVISION/DETAILS		DWN	DATE	DES	DATE							

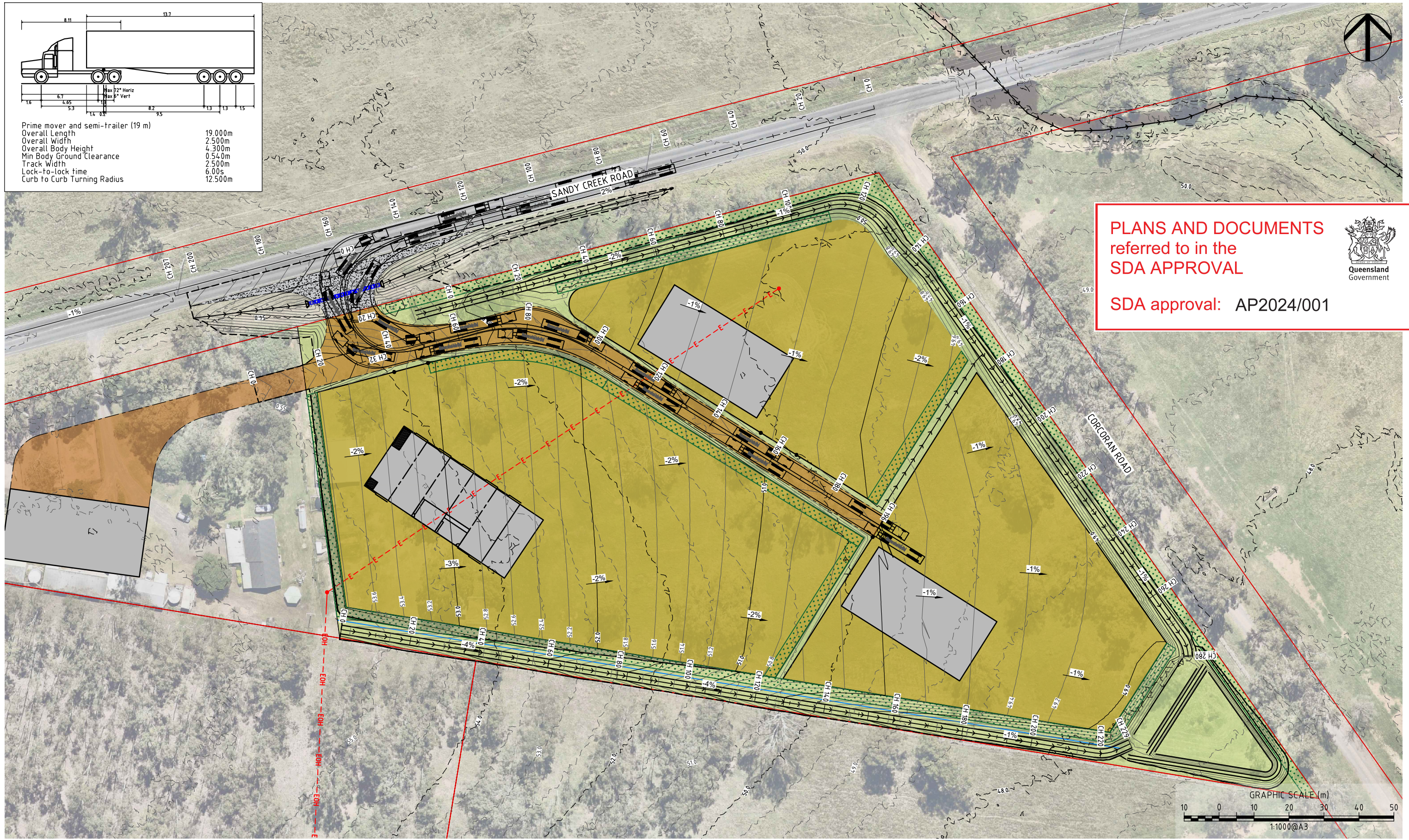
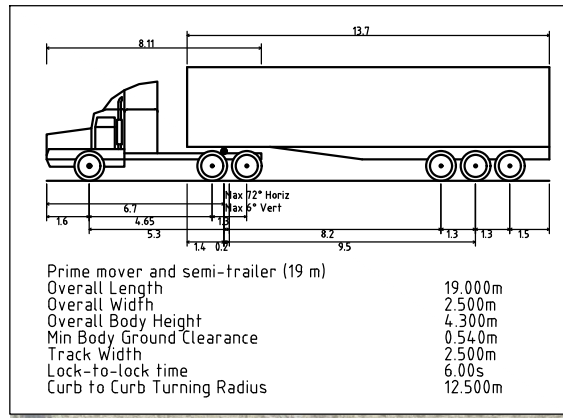

PLANS AND DOCUMENTS
 referred to in the
SDA APPROVAL

SDA approval: AP2024/001

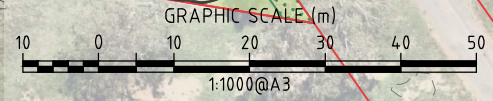
REVISION/DETAILS	DWN	DATE	DES	DATE
5 ACCESS LOCATION ADJUSTED AS PER RFI	NJF	30/01/25		
4 INCLUSION OF NOTES FOR PROPERTY ACCESS	MLS	11/06/24		
3 INCLUSION OF VEGETATION BUFFER, RELOCATED DRAIN	MLS	22/04/24		
2 FOR APPROVAL	NJF	10/04/24		
1 PRELIMINARY	NJF	28/09/23		

SURVEY DATA	
BEAUDESERT & BOONAH CRANES	DATUM
48 KOOROOMBA DRIVE, MT ALFORD QLD 4310	MAP GRID
BEAUDESERT & BOONAH CRANES	HEIGHT ORIGIN
149 SANDY CREEK ROAD, BROMELTON QLD 4285	SURVEY BOOKS

TURNING TEMPLATES			
ENGINEERING CERTIFICATION (RPEQ)			
#	FIELD	NAME	SIGNATURE
13697	CIVIL	S. SHAY	
			DATE
			30/01/25

P.O. Box 554 Beaudesert QLD 4285 (07) 5541 3500 www.acsengineers.com.au	ACS Engineers CIVIL ENVIRONMENTAL PROJECT MANAGEMENT
DRAWING NUMBER	REVISION
ACS-230068-GEN-06	5

NOTE: DETAILED DIMENSIONS AS PER TTM TRAFFIC ENGINEERING REPORT (TTM, MAY 2024) AND TO SUIT TURNING MANOEUVRE OF LARGEST ANTICIPATED VEHICLES.

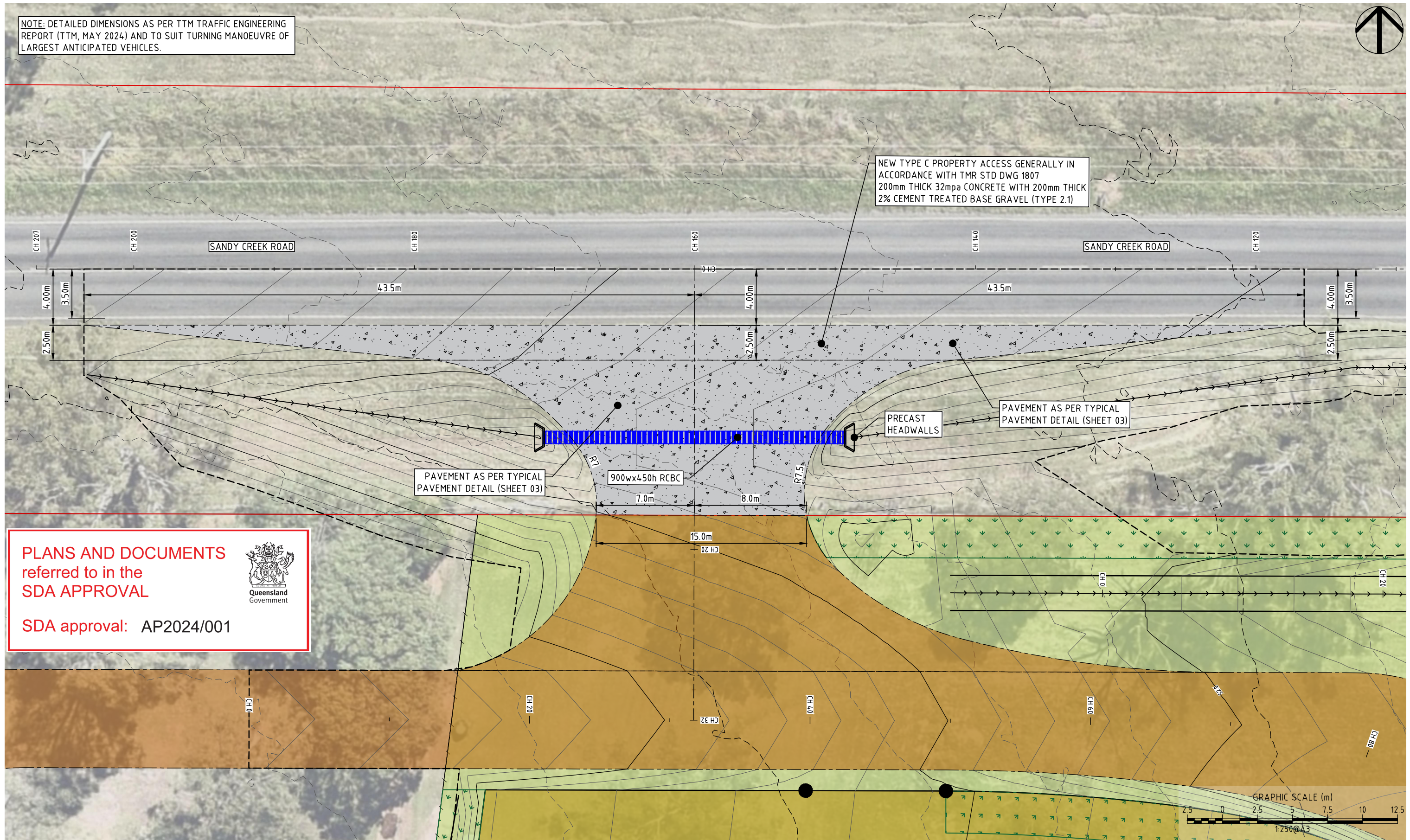

PLANS AND DOCUMENTS
referred to in the
SDA APPROVAL

SDA approval: AP2024/001



REVISION/DETAILS	DWN	DATE	DES	DATE
6 ACCESS LOCATION ADJUSTED AS PER RFI		30/01/25		
5 UPDATES TO TYPICAL SECTIONS (CONCRETE ACCESS)	NJF	18/11/24		
4 INCLUSION OF NOTES FOR PROPERTY ACCESS	MLS	11/06/24		
3 INCLUSION OF VEGETATION BUFFER, RELOCATED DRAIN	MLS	22/04/24		
2 FOR APPROVAL	NJF	10/04/24		
1 PRELIMINARY	NJF	28/09/23		

SURVEY DATA	BEAUDESERT & BOONAH CRANES
DATUM	48 KOOROomba DRIVE, MT ALFORD QLD 4310
MAP GRID	
HEIGHT ORIGIN	
SURVEY BOOKS	
	BEAUDESERT & BOONAH CRANES
	149 SANDY CREEK ROAD, BROMELTON QLD 4285

PROPERTY ACCESS LAYOUT PLAN			
#	FIELD	ENGINEERING CERTIFICATION (RPEQ) NAME	DATE
13697	CIVIL	S. SHAY	30/01/25

P0 Box 554 Beaudesert QLD 4285 (07) 5541 3500 www.acsengineers.com.au	ACS Engineers CIVIL ENVIRONMENTAL PROJECT MANAGEMENT
DRAWING NUMBER ACS-230068-GEN-07	REVISION 6

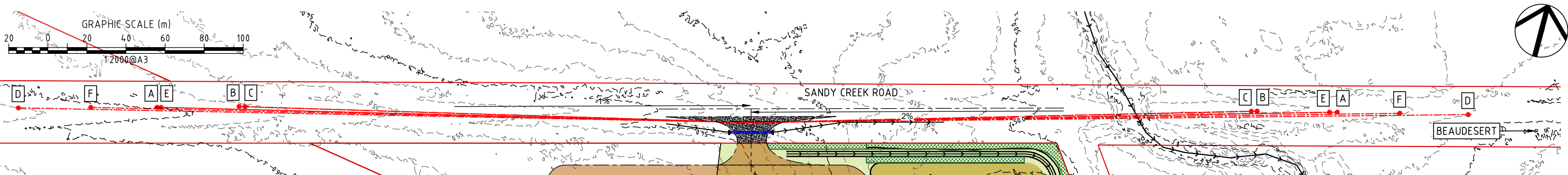

EASTBOUND										WESTBOUND									
NDD Check Cases										NDD Check Cases									
Table 3.2 & 3.3										Table 3.2 & 3.3									
ID	Case	V (km/hr)	h1 (m)	h2 (m)	Ot (s)	Rt (s)	d	a (%)	SISD (m)	ID	Case	V (km/hr)	h1 (m)	h2 (m)	Ot (s)	Rt (s)	d	a (%)	SISD (m)
A	Car Day	110	1.1	1.25	3	2.5	0.36	-1	304	A	Car Day	110	1.1	1.25	3	2.5	0.36	0	300
B	Car Night 1	110	0.65	1.25	2.6	2.5	0.46	-1	262	B	Car Night 1	110	0.65	1.25	2.6	2.5	0.46	0	259
C	Car Night 2	110	1.1	0.8	2.5	2.5	0.46	-1	259	C	Car Night 2	110	1.1	0.8	2.5	2.5	0.46	0	256
D	Truck Day	110	2.4	1.25	3	2.5	0.24	-1	375	D	Truck Day	110	2.4	1.25	3	2.5	0.24	0	367
Table 3.2 & 3.3										Table 3.2 & 3.3									
ID	Case	V (km/hr)	h1 (m)	h2 (m)	Ot (s)	Rt (s)	d	a (%)	SISD (m)	ID	Case	V (km/hr)	h1 (m)	h2 (m)	Ot (s)	Rt (s)	d	a (%)	SISD (m)
E	Truck Night 1	110	1.05	1.25	1.8	2.5	0.29	-1	302	E	Truck Night 1	110	1.05	1.25	1.8	2.5	0.29	0	296
F	Truck Night 2	110	2.4	0.8	3	2.5	0.29	-1	338	F	Truck Night 2	110	2.4	0.8	3	2.5	0.29	0	332

NOTE:
 1. SIGHT DISTANCE CHECKS BASED ON LIDAR.
 2. ON SITE SIGHT DISTANCE CHECKS CONFIRM THAT ALL SCENARIOS MEET REQUIREMENTS AND LOCATION IS SUITABLE.

PLANS AND DOCUMENTS referred to in the SDA APPROVAL
 Queensland Government
 SDA approval: AP2024/001

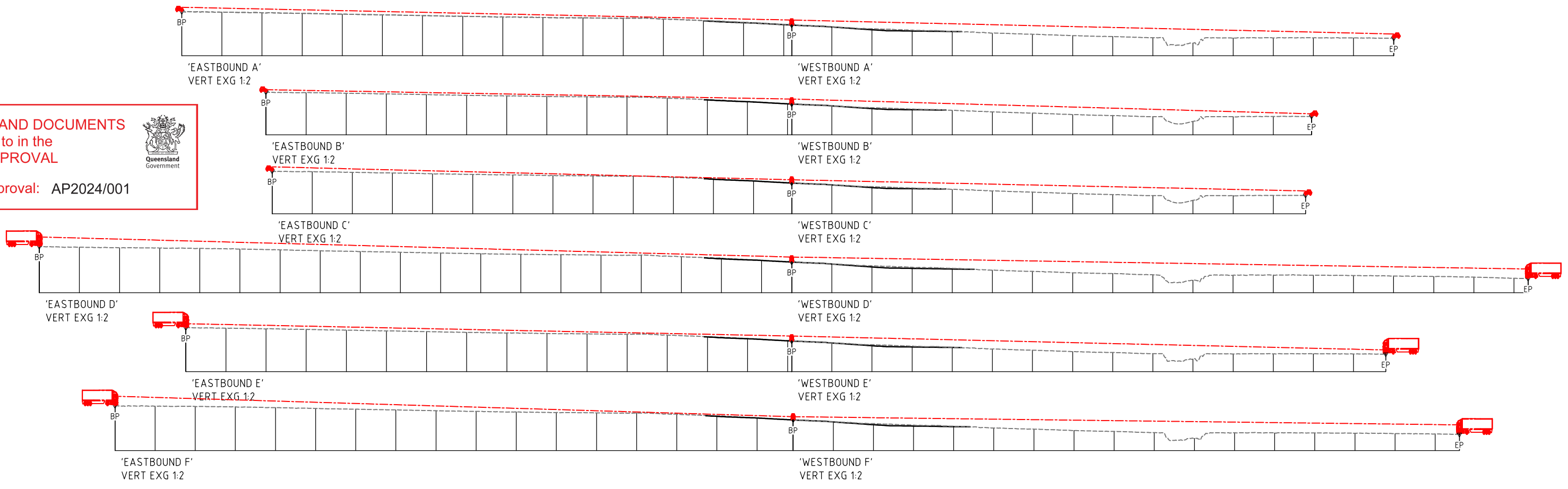

5	ACCESS LOCATION ADJUSTED AS PER RFI	NJF	30/01/25	SURVEY DATA	BEAUDESERT & BOONAH CRANES	SIGHT DISTANCE ASSESSMENT	ENGINEERING CERTIFICATION (RPEQ)			P0 Box 554 Beaudesert QLD 4285	ACS Engineers CIVIL ENVIRONMENTAL PROJECT MANAGEMENT	
4	INCLUSION OF NOTES FOR PROPERTY ACCESS	MLS	11/06/24	DATUM	48 KOOROOMBA DRIVE, MT ALFORD QLD 4310		#	FIELD	NAME	SIGNATURE		DATE
3	INCLUSION OF VEGETATION BUFFER, RELOCATED DRAIN	MLS	22/04/24	MAP GRID	BEAUDESERT & BOONAH CRANES		13697	CIVIL	S. SHAY	<i>S. Shay</i>		30/01/25
2	FOR APPROVAL	NJF	10/04/24	HEIGHT ORIGIN	149 SANDY CREEK ROAD, BROMELTON QLD 4285	DRAWING NUMBER			REVISION			
1	PRELIMINARY	NJF	28/09/23	SURVEY BOOKS		ACS-230068-GEN-08			5			
REVISION/DETAILS				DWN	DATE	DES	DATE					

PLANS AND DOCUMENTS
referred to in the
SDA APPROVAL



SDA approval: AP2024/001



REVISION/DETAILS	DWN	DATE	DES	DATE
5 ACCESS LOCATION ADJUSTED AS PER RFI	NJF	30/01/25		
4 INCLUSION OF NOTES FOR PROPERTY ACCESS	MLS	11/06/24		
3 INCLUSION OF VEGETATION BUFFER, RELOCATED DRAIN	MLS	22/04/24		
2 FOR APPROVAL	NJF	10/04/24		
1 PRELIMINARY	NJF	28/09/23		

SURVEY DATA	
BEAUDESERT & BOONAH CRANES	DATUM
48 KOOROOMBA DRIVE, MT ALFORD QLD 4310	MAP GRID
BEAUDESERT & BOONAH CRANES	HEIGHT ORIGIN
149 SANDY CREEK ROAD, BROMELTON QLD 4285	SURVEY BOOKS

STORMWATER LAYOUT PLAN			
ENGINEERING CERTIFICATION (RPEQ)			
#	FIELD	NAME	SIGNATURE
13697	CIVIL	S. SHAY	
			DATE
			30/01/25

P.O. Box 554 Beaudesert QLD 4285 (07) 5541 3500 www.acsengineers.com.au	ACS Engineers CIVIL ENVIRONMENTAL PROJECT MANAGEMENT
DRAWING NUMBER	REVISION
ACS-230068-GEN-09	5

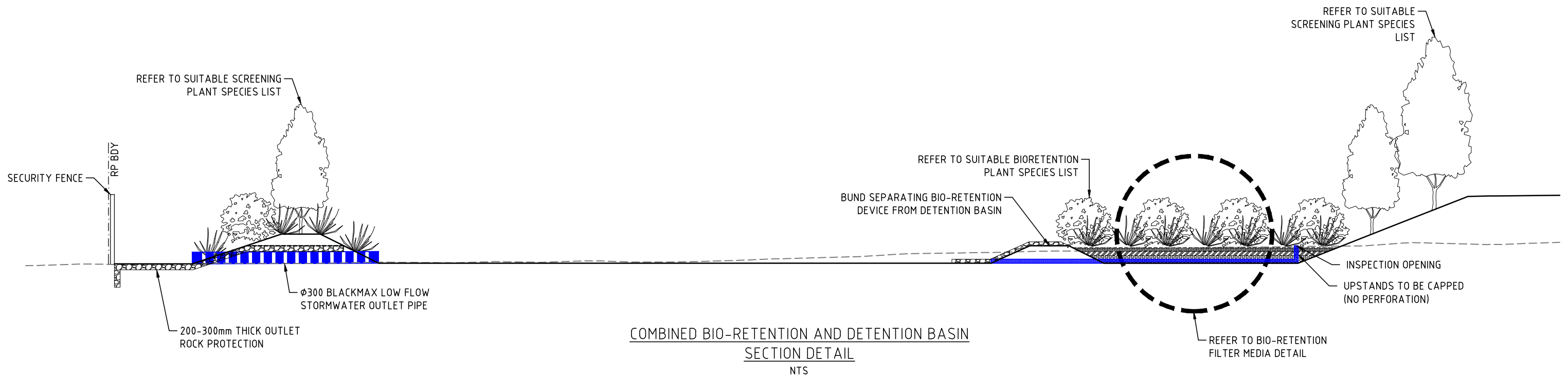

SUITABLE BIORETENTION PLANT SPECIES	
LOMANDRA	'SHARA'
THEMEDA TRIANDRA	'KANGAROO GRASS'
MELALEUCA THYMIFOLIA	'HONEY MYRTLE'
SUITABLE SCREENING SPECIES	
SYZYGIUM SMITHII	'LILLY PILLY'
PHOTINIA X FRASERI	'RED ROBIN'

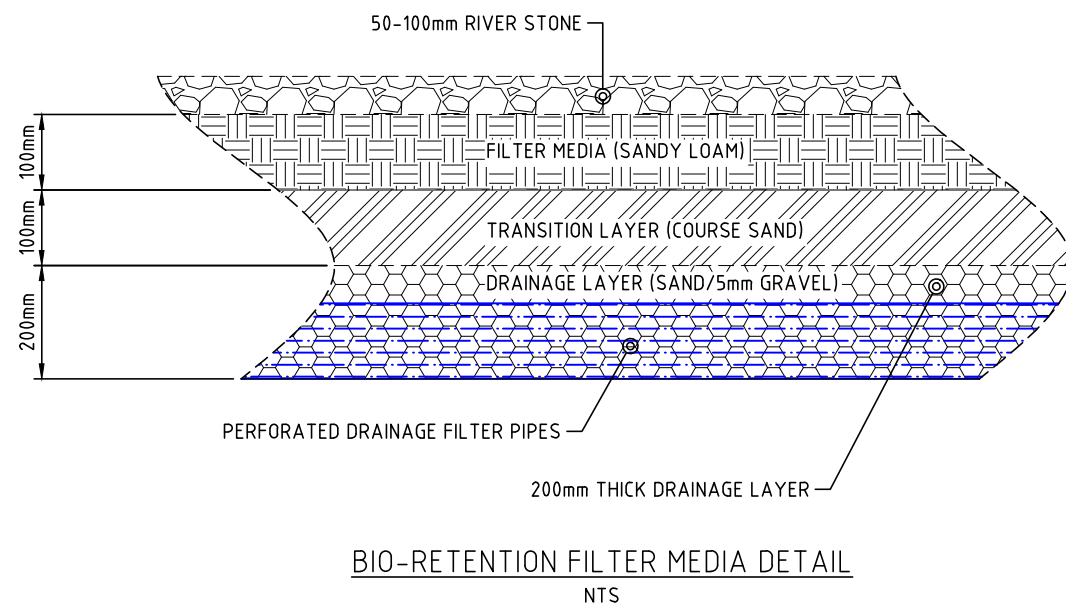

PLANS AND DOCUMENTS
referred to in the
SDA APPROVAL



SDA approval: AP2024/001

		SURVEY DATA		BEAUDESERT & BOONAH CRANES		BIO-DETENTION BASIN DETAILS			P0 Box 554 Beaudesert QLD 4285 (07) 5541 3500 www.acsengineers.com.au		ACS Engineers CIVIL ENVIRONMENTAL PROJECT MANAGEMENT	
4	INCLUSION OF NOTES FOR PROPERTY ACCESS	MLS	11/06/24	48 KOOROOMBA DRIVE, MT ALFORD QLD 4310					DRAWING NUMBER		REVISION	
3	INCLUSION OF VEGETATION BUFFER, RELOCATED DRAIN	MLS	22/04/24						ACS-230068-GEN-10		4	
2	FOR APPROVAL	NJF	10/04/24	BEAUDESERT & BOONAH CRANES		#	FIELD	ENGINEERING CERTIFICATION (RPEQ) NAME	SIGNATURE	DATE		
1	PRELIMINARY	NJF	28/09/23	149 SANDY CREEK ROAD, BROMELTON QLD 4285		13697	CIVIL	S. SHAY		30/01/25		
REVISION/DETAILS		DWN	DATE	DES	DATE							

SEDIMENT AND EROSION CONTROL - GENERAL NOTES:

- ADDITIONAL EROSION AND SEDIMENT CONTROL MEASURES MUST BE IMPLEMENTED AND A REVISED EROSION AND SEDIMENT CONTROL PLAN (ESCP) MUST BE SUBMITTED FOR APPROVAL IN THE EVENT THAT SITE CONDITIONS CHANGE SIGNIFICANTLY FROM THOSE CONSIDERED WITHIN THE CURRENT ESCP.
- WHERE THERE IS A HIGH PROBABILITY THAT SERIOUS OR MATERIAL ENVIRONMENTAL HARM MAY OCCUR AS A RESULT OF CURRENT SEDIMENT LEAVING THE SITE, APPROPRIATE ADDITIONAL EROSION AND SEDIMENT CONTROL MEASURES MUST BE IMPLEMENTED SUCH THAT ALL REASONABLE AND PRACTICABLE MEASURES ARE BEING TAKEN TO PREVENT OR MINIMISE SUCH HARM. ONLY THOSE WORKS NECESSARY TO MINIMISE OR PREVENT ENVIRONMENTAL HARM SHALL BE CONDUCTED ON-SITE PRIOR TO APPROVAL OF THE AMENDED EROSION AND SEDIMENT CONTROL PLAN (ESCP).
- IN CIRCUMSTANCES WHERE IT IS CONSIDERED NECESSARY TO PREPARE AN AMENDED EROSION AND SEDIMENT CONTROL PLAN (ESCP), AND WHERE THE DELIVERY OF SUCH AN AMENDED ESCP IS NOT IMMINENT, THEN ALL NECESSARY NEW OR MODIFIED EROSION AND SEDIMENT CONTROL WORKS MUST BE IN ACCORDANCE TO WITH IECA (2008) BEST PRACTICE EROSION & SEDIMENT CONTROL. UPON APPROVAL OF THE AMENDED ESCP ALL WORKS MUST BE IMPLEMENTED IN ACCORDANCE WITH THE AMENDED PLAN.

SITE ACCESS:

- PRIOR TO THE COMMENCEMENT OF SITE WORKS, THE LOCATION OF THE SITE ACCESS POINT MUST BE VERIFIED WITH RELEVANT LOCAL AUTHORITY.
- SITE ACCESS IS RESTRICTED TO ONE LOCATION.
- SITE EXIT POINT MUST BE APPROPRIATELY MANAGED TO MINIMISE THE RISK OF SEDIMENT BEING TRACKED ONTO SEALED PUBLIC ROADWAYS.
- STORMWATER RUNOFF FROM ACCESS ROADS AND STABILISED ENTRY/EXIT POINTS MUST DRAIN TO AN APPROPRIATE SEDIMENT CONTROL DEVICE.

LAND CLEARING

- LAND CLEARING MUST BE DELAYED AS LONG AS PRACTICABLE AND MUST BE UNDERTAKEN IN CONJUNCTION WITH DEVELOPMENT, UNLESS OTHERWISE APPROVED BY THE SUPERINTENDENT.
- ALL REASONABLE AND PRACTICABLE EFFORTS MUST BE TAKEN TO DELAY THE REMOVAL OF, OR DISTURBANCE TO, EXISTING GROUND COVER (ORGANIC OR INORGANIC) PRIOR TO LAND-DISTURBING ACTIVITIES.
- BULK TREE CLEARING MUST OCCUR IN A MANNER THAT MINIMISES DISTURBANCE TO EXISTING GROUND COVER (ORGANIC OR INORGANIC).
- BULK TREE CLEARING AND GRUBBING OF THE SITE MUST BE IMMEDIATELY FOLLOWED BY SPECIFIED TEMPORARY STABILISATION MEASURES (E.G. TEMPORARY GRASSING, OR MULCHING) PRIOR TO COMMENCEMENT OF EACH STAGE OF CONSTRUCTION WORKS.
- DISTURBANCE TO NATURAL WATERCOURSES (INCLUDING BED AND BANKS) AND THEIR ASSOCIATED RIPARIAN ZONES MUST BE LIMITED TO THE MINIMUM PRACTICABLE.
- NO LAND CLEARING SHALL BE UNDERTAKEN UNLESS PRECEDED BY THE INSTALLATION OF ADEQUATE DRAINAGE AND SEDIMENT CONTROL MEASURES, UNLESS SUCH CLEARING IS REQUIRED FOR THE PURPOSE OF INSTALLING SUCH MEASURES, IN WHICH CASE, ONLY THE MINIMUM CLEARING REQUIRED TO INSTALL SUCH MEASURES SHALL OCCUR.
- LAND CLEARING MUST BE LIMITED TO 5m FROM THE EDGE OF PROPOSED CONSTRUCTED WORKS, 2m OF ESSENTIAL CONSTRUCTION TRAFFIC ROUTES, AND A TOTAL OF 10m WIDTH FOR CONSTRUCTION ACCESS, UNLESS OTHERWISE APPROVED BY THE SUPERINTENDENT.
- PRIOR TO LAND CLEARING, AREAS OF PROTECTED VEGETATION, AND SIGNIFICANT AREAS OF RETAINED VEGETATION MUST BE CLEARLY IDENTIFIED (E.G. WITH HIGH-VISIBILITY TAPE, OR LIGHT FENCING) FOR THE PURPOSES OF MINIMISING THE RISK OF UNNECESSARY LAND CLEARING.
- ALL REASONABLE AND PRACTICABLE MEASURES MUST BE TAKEN TO MINIMISE THE REMOVAL OF, OR DISTURBANCE TO, THOSE TREES, SHRUBS AND GROUND COVERS (ORGANIC OR INORGANIC) THAT ARE INTENDED TO BE RETAINED.
- ALL LAND CLEARING MUST BE IN ACCORDANCE WITH THE FEDERAL, STATE AND LOCAL GOVERNMENT VEGETATION PROTECTION/PRESERVATION REQUIREMENTS AND/OR POLICIES.
- LAND CLEARING IS LIMITED TO THE MINIMUM PRACTICABLE DURING THOSE PERIODS WHEN SOIL EROSION DUE TO WIND, RAIN OR SURFACE WATER IS POSSIBLE.
- LAND CLEARING MUST NOT EXTEND BEYOND THAT NECESSARY TO PROVIDE UP TO EIGHT (8) WEEKS OF SITE ACTIVITY DURING THOSE MONTHS WHEN THE ACTUAL OR AVERAGE RAINFALL IS LESS THAN 45mm, SIX (6) IF BETWEEN 45 AND 100mm, FOUR (4) WEEKS IF BETWEEN 100 AND 225mm, AND TWO (2) WEEKS IF GREATER THAN 225mm.

SOIL AND STOCKPILE MANAGEMENT:

- ALL REASONABLE AND PRACTICABLE MEASURES MUST BE TAKEN TO OBTAIN THE MAXIMUM BENEFIT FROM EXISTING TOPSOIL, INCLUDING:
 - WHERE THE PROPOSED AREA OF SOIL DISTURBANCE DOES NOT EXCEED 2500m², AND THE TOPSOIL DOES NOT CONTAIN UNDESIRABLE WEED SEED, THE TOP 100mm OF SOIL LOCATED WITHIN AREAS OF PROPOSED SOIL DISTURBANCE (INCLUDING STOCKPILE AREAS) MUST BE STRIPPED AND STOCKPILED SEPARATELY FROM THE REMAINING SOIL.
 - WHERE THE PROPOSED AREA OF SOIL DISTURBANCE EXCEEDS 2500m², AND THE TOPSOIL DOES NOT CONTAIN UNDESIRABLE WEED SEED, THE TOP 50mm OF SOIL MUST BE STRIPPED AND STOCKPILED SEPARATELY FROM THE REMAINING TOPSOIL, AND SPREAD AS A FINAL SURFACE SOIL.
 - IN AREAS WHERE THE TOPSOIL CONTAINS UNDESIRABLE WEED SEED, THE AFFECTED SOIL MUST BE SUITABLY BURIED OR REMOVED FROM THE SITE.
- STOCKPILES OF ERODIBLE MATERIAL THAT HAS THE POTENTIAL TO CAUSE ENVIRONMENTAL HARM IF DISPLACED MUST BE:
 - APPROPRIATELY PROTECTED FROM WIND, RAIN, CONCENTRATED SURFACE FLOW AND EXCESSIVE UP-SLOPE STORMWATER SURFACE FLOWS.
 - LOCATED AT LEAST 2m FROM ANY HAZARDOUS AREA, RETAINED VEGETATION OR CONCENTRATED DRAINAGE LINE.
 - LOCATED UP-SLOPE OF AN APPROPRIATE SEDIMENT CONTROL SYSTEM.
 - PROVIDED WITH AN APPROPRIATE PROTECTIVE COVER (SYNTHETIC, MULCH OR VEGETATIVE) IF THE MATERIALS ARE LIKELY TO BE STOCKPILED FOR MORE THAN 28 DAYS.
 - PROVIDED WITH AN APPROPRIATE PROTECTIVE COVER (SYNTHETIC, MULCH OR VEGETATIVE) IF THE MATERIALS ARE LIKELY TO BE STOCKPILED FOR MORE THAN 10 DAYS DURING THOSE MONTHS THAT HAVE A HIGH EROSION RISK.
 - PROVIDED WITH AN APPROPRIATE PROTECTIVE COVER (SYNTHETIC, MULCH OR VEGETATIVE) IF THE MATERIALS ARE LIKELY TO BE STOCKPILED FOR MORE THAN 5 DAYS DURING THOSE MONTHS THAT HAVE A EXTREME EROSION RISK.
- A SUITABLE FLOW DIVERSION SYSTEM MUST BE ESTABLISHED IMMEDIATELY UP-SLOPE OF A STOCKPILE OF ERODIBLE MATERIAL THAT HAS THE POTENTIAL TO CAUSE ENVIRONMENTAL HARM IF DISPLACED IF THE UP-SLOPE CATCHMENT AREA DRAINING TO THE STOCKPILE EXCEEDS 1500m².

SITE MANAGEMENT:

- ALL OFFICE FACILITIES AND OPERATIONAL ACTIVITIES MUST BE LOCATED SUCH THAT ANY LIQUID EFFLUENT (E.G. PROCESS WATER, WASH-DOWN WATER, EFFLUENT FROM EQUIPMENT CLEANING, OR PLANT WATERING), CAN BE TOTALLY CONTAINED AND TREATED WITHIN THE SITE.
- THE CONSTRUCTION SCHEDULE MUST AIM TO MINIMISE THE DURATION THAT ANY AND ALL AREAS OF SOIL ARE EXPOSED TO THE EROSION EFFECTS OF WIND, RAIN AND SURFACE WATER.
- LAND-DISTURBING ACTIVITIES MUST BE UNDERTAKEN IN ACCORDANCE WITH THE EROSION AND SEDIMENT CONTROL PLAN (ESCP) AND ASSOCIATED DEVELOPMENT CONDITIONS.
- LAND-DISTURBING ACTIVITIES MUST BE UNDERTAKEN IN SUCH A MANNER THAT ALLOWS ALL REASONABLE AND PRACTICABLE MEASURES TO BE UNDERTAKEN TO:
 - ALLOW STORMWATER TO PASS THROUGH THE SITE IN A CONTROLLED MANNER AND AT NON-EROSIVE FLOW VELOCITIES UP TO THE SPECIFIED DESIGN STORM DISCHARGE;
 - MINIMISE SOIL EROSION RESULTING FROM RAIN, WATER FLOW AND/OR WIND;
 - MINIMISE ADVERSE EFFECTS OF SEDIMENT RUNOFF, INCLUDING SAFETY ISSUES;
 - PREVENT OR AT LEAST MINIMISE, ENVIRONMENTAL HARM RESULTING FROM WORK-RELATED SOIL EROSION AND SEDIMENT RUNOFF;
 - ENSURE THAT THE VALUE AND USE OF LAND/PROPERTIES ADJACENT TO THE DEVELOPMENT (INCLUDING ROADS) ARE NOT DIMINISHED AS A RESULT OF THE ADOPTED ESC MEASURES.
- ALL EROSION AND SEDIMENT CONTROL MEASURES MUST CONFORM TO THE STANDARDS AND SPECIFICATIONS CONTAINED IN:
 - THE DEVELOPMENT APPROVAL CONDITION ISSUED BY RELEVANT LOCAL AUTHORITY; AND/OR
 - THE APPROVED ESCP AND SUPPORTING DOCUMENTATION; OR
 - THE LATEST VERSION OF IECA (2008) BEST PRACTICE EROSION & SEDIMENT CONTROL IF THE STANDARDS AND SPECIFICATIONS ARE NOT CONTAINED IN THE APPROVED ESCP.
- ANY WORKS THAT MAY CAUSE SIGNIFICANT SOIL DISTURBANCE AND ARE ANCILLARY TO ANY ACTIVITY FOR WHICH REGULATORY BODY APPROVAL IS REQUIRED, MUST NOT COMMENCE BEFORE THE ISSUE OF THAT APPROVAL.
- ADDITIONAL AND/OR ALTERNATIVE ESC MEASURES MUST BE IMPLEMENTED IN THE EVENT THAT THE RELEVANT AUTHORITY IDENTIFIES THAT UNACCEPTABLE OFF-SITE SEDIMENTATION IS OCCURRING AS A RESULT OF THE WORK ACTIVITIES.
- LAND-DISTURBING ACTIVITIES MUST NOT CAUSE UNNECESSARY SOIL DISTURBANCE IF AN ALTERNATIVE CONSTRUCTION PROCESS IS AVAILABLE THAT ACHIEVES THE SAME OR EQUIVALENT OUTCOMES AT AN EQUIVALENT COST.
- SEDIMENT (INCLUDING CLAY, SILT, SAND, GRAVEL, SOIL, MUD, CEMENT AND CERAMIC WASTE) DEPOSITED OFF THE SITE AS A DIRECT RESULT OF AN ON-SITE ACTIVITY, MUST BE COLLECTED AND THE AREA APPROPRIATELY CLEANED/REHABILITATED AS SOON AS REASONABLE AND PRACTICABLE, AND IN A MANNER THAT GIVES APPROPRIATE CONSIDERATION TO THE SAFETY AND ENVIRONMENTAL RISKS ASSOCIATED WITH THE SEDIMENT DEPOSITION.
- ALL WASTE INCLUDING PETROLEUM AND OIL-BASED PRODUCTS, MUST BE PREVENTED FROM ENTERING AN INTERNAL WATER BODY, OR AN EXTERNAL DRAIN, STORMWATER SYSTEM, OR WATER BODY.
- ALL FLAMMABLE AND COMBUSTIBLE LIQUIDS, INCLUDING ALL LIQUID CHEMICALS IF SUCH CHEMICALS COULD POTENTIALLY BE WASHED OR DISCHARGED FROM THE SITE, ARE STORED AND HANDLED ON-SITE IN ACCORDANCE WITH RELEVANT STANDARDS SUCH AS AS1940 THE STORAGE AND HANDLING OF FLAMMABLE AND COMBUSTIBLE LIQUIDS.
- NO MORE THAN 150m OF A STORMWATER, SEWER LINE OR OTHER SERVICE TRENCH MUST TO BE OPEN AT ANY ONE TIME.
- SITE SPOIL MUST BE LAWFULLY DISPOSED OF IN A MANNER THAT DOES NOT RESULT IN ONGOING SOIL EROSION OR ENVIRONMENTAL HARM.
- ALL FILL MATERIAL PLACED ON SITE MUST COMPRISE ONLY NATURAL EARTH AND ROCK, AND IS TO BE FREE OF CONTAMINANTS, BE FREE DRAINING, AND BE COMPACTED IN LAYERS NOT EXCEEDING 300mm TO 90% MODIFIED MAXIMUM DRY DENSITY IN ACCORDANCE WITH AS1289.

DRAINAGE CONTROL:

- ALL DRAINAGE CONTROL MEASURES MUST BE APPLIED AND MAINTAINED IN ACCORDANCE WITH THE CONSTRUCTION PLANS.
- WHEREVER REASONABLE AND PRACTICABLE, STORMWATER RUNOFF ENTERING THE SITE FROM EXTERNAL AREAS, AND NON-SEDIMENT LADEN (CLEAN) STORMWATER RUNOFF ENTERING A WORK AREA OR AREA OF SOIL DISTURBANCE, MUST BE DIVERTED AROUND OR THROUGH THAT AREA IN A MANNER THAT MINIMISES SOIL EROSION AND THE CONTAMINATION OF THAT WATER FOR ALL DISCHARGES UP TO THE SPECIFIED DESIGN STORM DISCHARGE.
- DURING THE CONSTRUCTION PERIOD, ALL REASONABLE AND PRACTICABLE MEASURES MUST BE IMPLEMENTED TO CONTROL FLOW VELOCITIES IN SUCH A MANNER THAN PREVENTS SOIL EROSION ALONG DRAINAGE PATHS AND AT THE ENTRANCE AND EXIT OF ALL DRAINS AND DRAINAGE PIPES DURING ALL STORMS UP TO THE RELEVANT DESIGN STORM DISCHARGE.
- TO THE MAXIMUM DEGREE REASONABLE AND PRACTICABLE, ALL WATERS DISCHARGED DURING THE CONSTRUCTION PHASE MUST DISCHARGE ONTO STABLE LAND, IN A NON-EROSIVE MANNER, AND AT A LEGAL POINT OF DISCHARGE.
- WHEREVER REASONABLE AND PRACTICABLE, "CLEAN" SURFACE WATERS MUST BE DIVERTED AWAY FROM SEDIMENT CONTROL DEVICES AND ANY UNTREATED, SEDIMENT-LADEN WATERS.
- DURING THE CONSTRUCTION PERIOD, ROOF WATER MUST BE MANAGED IN A MANNER THAT MINIMISES SOIL EROSION THROUGHOUT THE SITE, AND SITE WETNESS WITHIN ACTIVE WORK AREAS.
- DRAINS ARE TO BE SIZED AND CONSTRUCTED TO ALLOW WATER TO DRAIN. THIS MAY INCLUDE CUTTING INTO THE EARTH TO OBTAIN THE REQUIRED FALL TO PERMIT DRAINAGE. DIMENSIONS GIVEN ARE A MINIMUM.

PLANS AND DOCUMENTS referred to in the SDA APPROVAL



SDA approval: AP2024/001

				SURVEY DATA	BEAUDESERT & BOONAH CRANES	ESC NOTES - SHEET 01			P0 Box 554 Beaudesert QLD 4285	ACS Engineers CIVIL ENVIRONMENTAL PROJECT MANAGEMENT		
				DATUM	48 KOOROOMBA DRIVE, MT ALFORD QLD 4310				(07) 5541 3500 www.acsengineers.com.au			
4	INCLUSION OF NOTES FOR PROPERTY ACCESS	MLS	11/06/24	MAP GRID					DRAWING NUMBER	REVISION		
3	INCLUSION OF VEGETATION BUFFER, RELOCATED DRAIN	MLS	22/04/24	HEIGHT ORIGIN	BEAUDESERT & BOONAH CRANES	#	FIELD	NAME	SIGNATURE	DATE		
2	FOR APPROVAL	NJF	10/04/24	SURVEY BOOKS		13697	CIVIL	S. SHAY		30/01/25	ACS-230068-GEN-11	4
1	PRELIMINARY	NJF	28/09/23		149 SANDY CREEK ROAD, BROMELTON QLD 4285							
REVISION/DETAILS				DWN	DATE	DES	DATE					

EROSION CONTROL:

- ALL EROSION CONTROL MEASURES MUST BE APPLIED AND MAINTAINED IN ACCORDANCE WITH IECA (2008) BEST PRACTICE EROSION & SEDIMENT CONTROL.
- THE APPLICATION OF LIQUID-BASED DUST SUPPRESSION MEASURES MUST ENSURE THAT SEDIMENT-LADEN RUNOFF RESULTING FROM SUCH MEASURES DOES NOT CREATE A TRAFFIC OR ENVIRONMENTAL HAZARD.
- ALL TEMPORARY EARTH BANKS, FLOW DIVERSION SYSTEMS, AND EMBANKMENTS ASSOCIATED WITH CONSTRUCTED SEDIMENT BASINS MUST BE MACHINE-COMPACTED, SEEDED AND MULCHED FOR THE PURPOSE OF ESTABLISHING A TEMPORARY VEGETATIVE COVER WITHIN 10 DAYS AFTER GRADING.
- UNPROTECTED SLOPE LENGTHS MUST NOT EXCEED 80m, OR AN EQUIVALENT VERTICAL FALL OF 3m DURING THE CONSTRUCTION PERIOD.
- THE CONSTRUCTION AND STABILISATION OF EARTH BATTERS STEEPER THAN 6:1 (H:V) MUST BE STAGED SUCH THAT NO MORE THAN 3 VERTICAL-METRES OF ANY BATTER IS EXPOSED TO RAINFALL AT ANY INSTANT.
- SYNTHETIC REINFORCED EROSION CONTROL MATS AND BLANKETS MUST NOT BE PLACED WITHIN, OR ADJACENT TO, RIPARIAN ZONES AND WATERCOURSES IF SUCH MATERIALS ARE LIKELY TO CAUSE ENVIRONMENTAL HARM TO WILDLIFE OR WILDLIFE HABITATS.
- A MINIMUM 60% GROUND COVER MUST BE ACHIEVED ON ALL NON-COMPLETED EARTHWORKS EXPOSED TO ACCELERATED SOIL EROSION IF FURTHER CONSTRUCTION ACTIVITIES OR SOIL DISTURBANCES ARE LIKELY TO BE SUSPENDED FOR MORE THAN 30 DAYS DURING THOSE MONTHS WHEN THE EXPECTED RAINFALL IS LESS THAN 30mm; MINIMUM 70% COVER WITHIN 30 DAYS IF BETWEEN 30 AND 45mm; MINIMUM 70% COVER WITHIN 20 DAYS IF BETWEEN 45 AND 100mm; MINIMUM 75% COVER WITHIN 10 DAYS IF BETWEEN 100 AND 225mm; AND MINIMUM 80% COVER WITHIN 5 DAYS IF GREATER THAN 225mm. (ALTERNATIVE TO ABOVE)

SEDIMENT CONTROL:

- ALL SEDIMENT CONTROL MEASURES MUST BE APPLIED AND MAINTAINED IN ACCORDANCE WITH IECA (2008) BEST PRACTICE EROSION & SEDIMENT CONTROL.
- OPTIMUM BENEFIT MUST BE MADE OF EVERY OPPORTUNITY TO TRAP SEDIMENT WITHIN THE WORK SITE, AND AS CLOSE AS PRACTICABLE TO ITS SOURCE.
- SEDIMENT TRAPS MUST BE INSTALLED AND OPERATED TO BOTH COLLECT AND RETAIN SEDIMENT.
- THE POTENTIAL SAFETY RISK OF A PROPOSED SEDIMENT TRAP TO SITE WORKERS AND THE PUBLIC MUST BE GIVEN APPROPRIATE CONSIDERATION, ESPECIALLY THOSE DEVICES LOCATED WITHIN PUBLICLY ACCESSIBLE AREAS.
- ALL REASONABLE AND PRACTICABLE MEASURES MUST BE TAKEN TO PREVENT, OR AT LEAST MINIMISE, THE RELEASE OF SEDIMENT FROM THE SITE.
- SUITABLE ALL-WEATHER MAINTENANCE ACCESS MUST BE PROVIDED TO ALL SEDIMENT CONTROL DEVICES.
- SEDIMENT CONTROL DEVICES MUST BE DE-SILTED AND MADE FULLY OPERATIONAL AS SOON AS REASONABLE AND PRACTICABLE AFTER A SEDIMENT-PRODUCING EVENT, WHETHER NATURAL OR ARTIFICIAL, IF THE DEVICE'S SEDIMENT RETENTION CAPACITY REDUCES BY 30% OF DESIGN CAPACITY.
- MATERIALS, WHETHER LIQUID OR SOLID, REMOVED FROM SEDIMENT CONTROL DEVICES DURING MAINTENANCE OR DECOMMISSIONING, MUST BE DISPOSED OF IN A MANNER THAT DOES NOT CAUSE ONGOING SOIL EROSION OR ENVIRONMENTAL HARM.

ROADWORKS:

- VEGETATION REMOVED DURING ROAD WORKS MUST BE RE-USED TO THE MAXIMUM POSSIBLE EXTENT TO MINIMISE SHORT AND LONG-TERM SOIL EROSION. NON-SALVAGEABLE DEBRIS MUST BE DISPOSED OF IN A MANNER THAT DOES NOT CAUSE ONGOING ENVIRONMENTAL HARM.
- SOIL DISTURBANCES MUST BE STAGED INTO MANAGEABLY-SIZED AREAS OF NO GREATER THAN TEN (10) HECTARES TO ENSURE ADEQUATE ESC MANAGEMENT AND PROGRESSIVE STABILISATION OF DISTURBED SURFACES.
- NEWLY CONSTRUCTED SPRAY-SEALED ROADS MUST BE SWEEPED THOROUGHLY AS SOON AS POSSIBLE AFTER GRAVELLING TO PREVENT EXCESS GRAVEL ENTERING STORMWATER DRAINS OR WATERWAYS.
- DURING THE CONSTRUCTION PERIOD, ALL UNSTABLE FILL EMBANKMENTS ARE TO BE LEFT WITH A LIP (WINDROW) AT THE TOP OF THE SLOPE AT THE END OF EACH DAY'S OPERATION, OR OTHER APPROPRIATE DRAINAGE CONTROL MEASURES, TO PREVENT BANK EROSION.
- ALL CUT AND FILL EARTH BATTERS ARE TO BE TOPSOILED, AND GRASS SEEDED/HYDROMULCHED WITHIN TEN (10) DAYS OF COMPLETION OF GRADING.

SITE REHABILITATION:

- ALL DISTURBED AREAS IDENTIFIED AS VERY LOW, LOW, MEDIUM, HIGH, OR EXTREME EROSION RISK MUST BE SUITABLY STABILISED WITHIN 30, 30, 20, 10 OR 5 DAYS RESPECTIVELY, OR PRIOR TO ANTICIPATED RAINFALL, WHICHEVER IS THE GREATER, FROM THE DAY THAT SOIL DISTURBANCES ON THE AREA HAVE BEEN FINALISED.
- A MINIMUM 60% GROUND COVER MUST BE ACHIEVED ON ALL COMPLETED EARTHWORKS EXPOSED TO ACCELERATED SOIL EROSION WITHIN 30 DAYS DURING THOSE MONTHS WHEN THE EXPECTED RAINFALL IS LESS THAN 30mm; MINIMUM 70% COVER WITHIN 30 DAYS IF BETWEEN 30 AND 45mm; MINIMUM 70% COVER WITHIN 20 DAYS IF BETWEEN 45 AND 100mm; MINIMUM 75% COVER WITHIN 10 DAYS IF BETWEEN 100 AND 225mm; AND MINIMUM 80% COVER WITHIN 5 DAYS IF GREATER THAN 225mm. (ALTERNATIVE TO ABOVE)
- NO COMPLETED EARTHWORK SURFACE MUST REMAIN DENUDED FOR LONGER THAN 60 DAYS.
- THE TYPE OF GROUND COVER APPLIED TO COMPLETED EARTHWORKS IS COMPATIBLE WITH THE ANTICIPATED LONG-TERM LAND USE, ENVIRONMENTAL RISK, AND SITE REHABILITATION MEASURES.
- UNLESS OTHERWISE DIRECTED BY THE SUPERINTENDENT OR WHERE DIRECTED BY THE APPROVED REVEGETATION PLAN, TOPSOIL MUST BE PLACED AT A MINIMUM DEPTH OF 75mm ON SLOPES 4:1 (H:V) OR FLATTER, AND 50mm ON SLOPES STEEPER THAN 4:1.
- SOIL AMELIORANTS MUST BE ADDED TO THE SOIL IN ACCORDANCE WITH THE APPROVED LANDSCAPE/REVEGETATION PLANS AND/OR SOIL ANALYSIS.
- TEMPORARY SITE STABILISATION PROCEDURES MUST COMMENCE AT LEAST 30 DAYS PRIOR TO THE NOMINATED SITE SHUTDOWN DATE. AT LEAST 70% STABLE COVER OF ALL UNSTABLE AND/OR DISTURBED SOIL SURFACES MUST BE ACHIEVED PRIOR TO ANY SHUTDOWN. THE STABILISATION WORKS MUST NOT RELY UPON THE LONGEVITY OF NON-VEGETATED EROSION CONTROL BLANKETS, OR TEMPORARY SOIL BINDERS.
- ALL UNSTABLE OR DISTURBED SOIL SURFACES MUST BE ADEQUATELY STABILISED AGAINST EROSION (MINIMUM 70%) PRIOR TO COMMENCEMENT OF USE, OR SURVEY PLAN ENDORSEMENT.

SITE MAINTENANCE:

- ENSURE ESC PLANS ARE ON SITE AT ALL TIMES.
- ALL EROSION AND SEDIMENT CONTROL MEASURES, INCLUDING DRAINAGE CONTROL MEASURES, MUST BE MAINTAINED IN PROPER WORKING ORDER AT ALL TIMES DURING THEIR OPERATIONAL LIVES.
- ALL TEMPORARY EROSION AND SEDIMENT CONTROL MEASURES, INCLUDING DRAINAGE CONTROL MEASURES, MUST BE FULLY OPERATIONAL AND MAINTAINED IN PROPER WORKING ORDER AT ALL TIMES DURING THE MAINTENANCE PERIOD AS SPECIFIED BY RELEVANT AUTHORITY.
- ALL TEMPORARY EROSION AND SEDIMENT CONTROL MEASURES, INCLUDING DRAINAGE CONTROL MEASURES, MUST BE REMOVED AFTER ACHIEVING A SATISFACTORY "OFF-MAINTENANCE INSPECTION" BY THE RELEVANT AUTHORITY.
- ALL DRAINAGE, EROSION AND SEDIMENT CONTROL MEASURES MUST BE INSPECTED:
 - AT LEAST DAILY (WHEN WORK IS OCCURRING ON-SITE);
 - AT LEAST WEEKLY (WHEN WORK IS NOT OCCURRING ON-SITE);
 - WITHIN 24 HOURS OF EXPECTED RAINFALL; AND
 - WITHIN 18 HOURS OF A RAINFALL EVENT OF SUFFICIENT INTENSITY AND DURATION TO CAUSE RUNOFF ON-SITE).
 IF FAILURE HAS BEEN FOUND, IMMEDIATE REMEDIATIONS ARE REQUIRED AND TO A STANDARD WHICH ENSURES THE FAILURE DOES NOT CONTINUALLY OCCUR UNDER DESIGN RAINFALL CONDITIONS.
- WASHING/FLUSHING OF SEALED ROADWAYS MUST ONLY OCCUR WHERE SWEEPING HAS FAILED TO REMOVE SUFFICIENT SEDIMENT AND THERE IS A COMPELLING NEED TO REMOVE THE REMAINING SEDIMENT (E.G. FOR SAFETY REASONS). IN SUCH CIRCUMSTANCES, ALL REASONABLE AND PRACTICABLE SEDIMENT CONTROL MEASURES MUST BE USED TO PREVENT, OR AT LEAST MINIMISE, THE RELEASE OF SEDIMENT INTO RECEIVING WATERS. ONLY THOSE MEASURES THAT WILL NOT CAUSE SAFETY AND PROPERTY FLOODING ISSUES SHALL BE EMPLOYED. SEDIMENT REMOVED FROM ROADWAYS MUST BE DISPOSED OF IN A LAWFUL MANNER THAT DOES NOT CAUSE ONGOING SOIL EROSION OR ENVIRONMENTAL HARM.
- SEDIMENT REMOVED FROM SEDIMENT TRAPS AND PLACES OF SEDIMENT DEPOSITION MUST BE DISPOSED OF IN A LAWFUL MANNER THAT DOES NOT CAUSE ONGOING SOIL EROSION OR ENVIRONMENTAL HARM.
- MAINTENANCE IS TO OCCUR ON ALL EROSION AND SEDIMENT CONTROL MEASURES WHEN CAPACITY REDUCES BY 30%.
- MAINTENANCE MOWING OF ALL ROAD SHOULDERS, TABLE DRAINS, BATTERS AND OTHER SURFACES LIKELY TO EXPERIENCE ACCELERATED SOIL EROSION MUST AIM TO LEAVE THE GRASS LENGTH NO SHORTER THAN 50mm WHERE REASONABLE AND PRACTICABLE.
- MAINTENANCE MOWING MUST BE DONE IN A MANNER THAT WILL NOT DAMAGE THE PROFILE OF FORMED, SOFT EDGES, SUCH AS THE CREST OF EARTH EMBANKMENTS.
- ENSURE RECORDS ARE KEPT OF DATES OF MAINTENANCE AND THE PERSONNEL RESPONSIBLE FOR UNDERTAKING THE MAINTENANCE.
- IT IS THE CONTRACTORS RESPONSIBILITY TO ENSURE SOIL EROSION IS LIMITED AS MUCH AS POSSIBLE. THE TECHNIQUES USED IN THE DESIGN SHOULD NOT BE TAKEN AS THE MAXIMUM CONTROLS ALLOWABLE, AND THE CONTRACTOR MAY ADD CONTROLS AS NECESSARY TO LIMIT SOIL EROSION AND SEDIMENTATION.
- MONITORING SHALL BE UNDERTAKEN BY A PERSON WITH EXPERIENCE IN EROSION AND SEDIMENT CONTROL MONITORING. MONITORING IS TO BE UNDERTAKEN IN A MANNER WHICH COMPLIES WITH IECA GUIDELINES 2008, CHAPTER 7. SITE INSPECTION.

OTHER:

- THE CONTRACTOR IS TO TAKE ALL NECESSARY PRECAUTIONS TO CONTROL EROSION AND DOWNSTREAM SEDIMENTATION DURING ALL STAGES OF CONSTRUCTION INCLUDING THE MAINTENANCE PERIOD.
- ALL SEDIMENT CONTROL DEVICES SHALL BE MONITORED, CLEANED AND/OR REPAIRED WHENEVER THE ACCUMULATED SEDIMENT REDUCES THE CAPACITY BY 30%.
- THE EXTENT OF GRASSING SHALL BE DETERMINED BY THE SUPERINTENDENT AND SHALL BE SEEDED, AS SPECIFIED, WITHIN SEVEN DAYS OF FINAL TRIMMING.
- EXTENT AND POSITION OF SILT FENCE CONTROL MEASURES TO BE DETERMINED ON SITE BY SUPERINTENDENT.
- MEASURES SHOWN ON THIS DRAWING ARE MINIMUM REQUIREMENTS ONLY.
- SCOUR PROTECTION AND SILT MANAGEMENT MEASURES TO BE PROVIDED AT STORMWATER OUTLET HEADWALLS.
- PROVISION TO BE MADE FOR DIRT/SAND REMOVAL FROM CONSTRUCTION VEHICLES PRIOR TO TRAVEL ON PUBLIC ROADS. METHOD TO BE APPROVED BY SUPERINTENDENT PRIOR TO COMMENCEMENT OF WORK.
- ANY SILT OR SEDIMENT CAUSED BY CONSTRUCTION TRAFFIC ON EXISTING ROADS IS TO BE REMOVED DAILY.
- THE CONTRACTOR SHALL IMPLEMENT EROSION AND SEDIMENT CONTROL PROCEDURES DURING CONSTRUCTION AND MAINTENANCE STAGES OF THE DEVELOPMENT AND SHALL TAKE ALL NECESSARY ACTIONS TO COMPLY WITH THE POLICY OBJECTIVES OF COUNCIL'S LOCAL PLANNING POLICY - EROSION AND SEDIMENT CONTROL.
- A SCHEDULE SHALL BE SUBMITTED FOR THE APPROVAL OF COUNCIL'S REPRESENTATIVE AT THE PRE-START MEETING FOR THE FIELD IMPLEMENTATION OF EROSION AND SEDIMENT CONTROL, DETAILING THE STAGES AT WHICH VARIOUS MANAGEMENT TECHNIQUES WOULD BE IN PLACE AND AUDITING PROCEDURES.
- FINAL FORM OF SEDIMENT EROSION CONTROL TO BE DECIDED ON SITE BY THE SUPERINTENDENT.
- THE CONTRACTOR IS TO ENSURE THAT NO SILT REACHES THE DOWNSTREAM WATER COURSE AND IS TO PROVIDE ADEQUATE PROTECTION TO PREVENT THIS OCCURRING.

ROCK CHECK DAMS, SAND BAG CHECK DAMS AND COIR LOGS:

- TO BE LOCATED AS DIRECTED ON SITE AND SPACED TO SUIT SETOUT DETAIL, REFER DRG 04.
- MAINTENANCE OF CHECK DAMS TO BE IN ACCORDANCE WITH 'IECA BEST PRACTICE EROSION AND SEDIMENT CONTROL BOOK 6 STANDARD DRAWINGS'.

LEVEL SPREADERS:

- TO BE LOCATED AS DIRECTED ON SITE, TYPICALLY MAX. SPACING OF 120m. MAINTENANCE OF CHECK DAMS TO BE IN ACCORDANCE WITH 'IECA BEST PRACTICE EROSION AND SEDIMENT CONTROL BOOK 6 STANDARD DRAWINGS'.

PLANS AND DOCUMENTS referred to in the SDA APPROVAL
 SDA approval: AP2024/001



				SURVEY DATA		BEAUDESERT & BOONAH CRANES		ESC NOTES - SHEET 02		P.O. Box 554 Beaudesert QLD 4285		 CIVIL ENVIRONMENTAL PROJECT MANAGEMENT		
				DATUM		48 KOOROOMBA DRIVE, MT ALFORD QLD 4310				(07) 5541 3500 www.acsengineers.com.au				
4	INCLUSION OF NOTES FOR PROPERTY ACCESS	MLS	11/06/24	MAP GRID						DRAWING NUMBER		REVISION		
3	INCLUSION OF VEGETATION BUFFER, RELOCATED DRAIN	MLS	22/04/24	HEIGHT ORIGIN						ACS-230068-GEN-12		4		
2	FOR APPROVAL	NJF	10/04/24	SURVEY BOOKS										
1	PRELIMINARY	NJF	28/09/23											
REVISION/DETAILS				DWN	DATE	DES	DATE	ENGINEERING CERTIFICATION (RPEQ) # FIELD NAME SIGNATURE DATE						
								13697	CIVIL	S. SHAY		30/01/25		
								149 SANDY CREEK ROAD, BROMELTON QLD 4285						

SILT & SEDIMENTATION NOTES

- DESIGNED IN ACCORDANCE WITH SOIL EROSION AND SEDIMENT CONTROL ENGINEERING GUIDELINES FOR QUEENSLAND & REGULATORY AUTHORITIES REQUIREMENTS.
- ALL WORK, FIXTURES, FITTINGS & STRUCTURES SHALL COMPLY WITH & BE CARRIED OUT TO SOIL EROSION & SEDIMENT CONTROL ENGINEERING GUIDELINES OF QLD REGULATORY AUTHORITIES REQUIREMENTS.
- PROVIDE, INSTALL AND MAINTAIN ALL BARRIERS, GROSS POLLUTANT TRAPS, CONSTRUCTION EXITS, PUMP SUCTION PITS, POLLUTANT AND SEDIMENT TRAPS FENCES NECESSARY FOR THE CONTROL OF EROSION AND SEDIMENTATION WITHIN AND AROUND THE SITE DURING CONSTRUCTION. ALL IN ACCORDANCE WITH SOIL EROSION AND SEDIMENT CONTROL ENGINEERING GUIDELINES FOR QUEENSLAND & REGULATORY AUTHORITIES REQUIREMENTS.
- EXACT DETAIL, TYPE & EXTENT OF SEDIMENT FENCE SHALL BE DETERMINED ON SITE IN CONJUNCTION WITH REGULATORY AUTHORITY TO ACHIEVE & MAINTAIN A SUITABLE LEVEL OF PERFORMANCE FOR THE EXPECTED FLOWS, INCLUDING POSSIBLE OVERLAND FLOWS.
- PROVIDE AND INSTALL 750mm HIGH SEDIMENT FENCE AROUND SITE. EXACT EXTENT OF FENCE SHALL BE DETERMINED ON SITE IN CONJUNCTION WITH REGULATORY AUTHORITY.
- PROVIDE AND INSTALL 450mm HIGH SEDIMENT FENCE COMPLETELY AROUND ALL OPEN STORMWATER PIPES AT THE END OF EACH DAYS WORK & IMMEDIATELY PRIOR TO ANY STORM EVENT.
- PROVIDE AND INSTALL 450mm HIGH SEDIMENT FENCE COMPLETELY AROUND ALL SWS's, GRATED TRENCHES & GRATES.
- PROVIDE AND INSTALL CONSTRUCTION ENTRY / EXIT SEDIMENT CONTROL STRUCTURE.
- PROVIDE AND INSTALL SEDIMENT BARRIERS TO ALL EXISTING ROAD INLET GULLIES AFFECTED BY CONSTRUCTION. CONSTRUCTION OF ALL SEDIMENT MANAGEMENT DEVICES SHALL BE COMPLETED AND EFFECTIVE PRIOR TO STRIPPING OF TOP SOIL AND GRASS, BULK EARTHWORKS TO SITE, AND SERVICE INSTALLATION.
- ALL SEDIMENT MANAGEMENT DEVICES ARE TO REMAIN IN PLACE UNTIL WRITTEN NOTICE FROM LICENSING AND COMPLIANCE.
- BOTH TEMPORARY AND PERMANENT SEDIMENTATION MANAGEMENT DEVICES SHALL BE MAINTAINED AT A SUITABLE LEVEL / CONDITION THROUGHOUT CONSTRUCTION. SEDIMENT FENCES ARE TO BE CLEANED OUT WHEN CAPACITY IS REDUCED BY 30%.
- PRIOR TO COMMENCEMENT OF CONSTRUCTION, APPROVAL SHALL BE OBTAINED FROM LICENSING AND COMPLIANCE FOR THE LOCATION OF THE SITE ACCESS POINT AND WASH DOWN AREA WHICH SHALL BE MAINTAINED THROUGHOUT THE CONSTRUCTION PERIOD.
- IF EROSION AND SEDIMENT CONTROL DEVICES HAVE BEEN FOUND TO BE DEFICIENT OR FAILED IN SERVICE, DUE TO UNFORESEEN CIRCUMSTANCES, CORRECTIVE ACTION IS TO BE UNDERTAKEN IMMEDIATELY WHICH MAY INCLUDE AMENDMENTS / ADDITIONS TO THE ORIGINAL EROSION CONTROL PLANS. SUCH ADDITIONS OR AMENDMENTS ARE TO BE APPROVED BY LICENSING AND COMPLIANCE OFFICER AND REGULATORY AUTHORITY.
- THE INSTALLATION, REMOVAL, RELOCATION, OR MODIFICATION TO EROSION AND SEDIMENT CONTROL DEVICES MAY BE MADE BY A LICENSING AND COMPLIANCE OFFICER AND REGULATORY AUTHORITY IF DEEMED NECESSARY AND RELEVANT.
- ALL MUD TRACKED ONTO COUNCIL ROADS SHALL BE BROOMED OFF IMMEDIATELY (NOT WASHED OFF INTO COUNCIL STORMWATER SYSTEM).
- ADDITIONAL SEDIMENT AND EROSION CONTROL MEASURES ARE TO BE IMPLEMENTED DURING CONSTRUCTION IF DIRECTED BY COUNCIL REPRESENTATIVE.

EROSION & SEDIMENT CONTROL PROGRAM

- MESH AND INLET PROTECTION DEVICES TO ALL GULLY PITS TO BE REMOVED DURING CONSTRUCTION OF ROADWAYS. AFTER ROADS HAVE BEEN COMPLETED CONTRACTOR TO ENSURE ALL GULLY GRATES ARE WRAPPED IN GEOFABRIC AND ROCK FILLED AGRICULTURAL PIPE PLACED ALONG LINTELS. (REFER DETAIL).
- MESH AND INLET PROTECTION DEVICES TO FIELD INLETS TO REMAIN UNTIL SWALES HAVE BEEN TOPSOILED AND TURFED.
- SEDIMENT PONDS TO BE REMOVED AT THE COMPLETION OF ALL WORKS OR WHEN ALL ALLOTMENTS HAVE 80% GRASS COVERAGE.
- SEDIMENT FENCES TO REMAIN ALONG PROPERTY BOUNDARIES AND TO BE MAINTAINED/REPLACED DURING THE 'ON MAINTENANCE' PERIOD OR UNTIL LOTS ARE SOLD AND BUILDING CONSTRUCTION COMMENCES.
- THE CONTRACTOR TO REMOVE GULLY PIT PROTECTION DEVICES AFTER SUCCESSFUL 'ON MAINTENANCE' INSPECTION.
- THE CONTRACTOR IS RESPONSIBLE FOR MAINTENANCE OF ALL SEDIMENT CONTROL DEVICES DURING CONSTRUCTION UNTIL AFTER SUCCESSFUL 'ON MAINTENANCE' INSPECTION.

RELEASE LIMITS

ALL RELEASE OF STORMWATER CAPTURED IN A SEDIMENT BASIN MUST NOT EXCEED THE FOLLOWING LIMITS:

- 50mg/L OF TOTAL SUSPENDED SOLIDS (TSS) AS A MAXIMUM CONCENTRATION;
- TURBIDITY (NTU) VALUE LESS THAN 10% ABOVE BACKGROUND;
- pH VALUE MUST BE IN THE RANGE 6.5 TO 8.5 EXCEPT WHERE, AND TO THE EXTENT THAT, THE NATURAL RECEIVING WATERS LIE OUTSIDE THIS RANGE

MAINTENANCE OF PUBLIC ROADS

- ALL CONSTRUCTION VEHICLES DEPARTING THE SITE SHALL HAVE THEIR TYRES WASHED DOWN.
- THE CONTRACTOR SHALL INSPECT THE PUBLIC ROADS ADJACENT TO THE SITE DAILY AND REMOVE ANY SOIL OR SILT DEPOSITS.
- THE CONTRACTOR SHALL PROVIDE A WASH-DOWN AREA AND ANY STORMWATER INLETS ADJACENT TO THIS AREA ARE TO BE PROTECTED FROM SILT INFILTRATION.
- THE WASH-DOWN AREA SHALL BE LOCATED SUCH THAT SILTED WATER IS FILTERED PRIOR TO LEAVING THE SITE. SHOULD THE WATER POND IT MUST BE TESTED IN ACCORDANCE WITH THE EROSION AND SEDIMENT CONTROL PROGRAM PRIOR TO DISPOSAL.

CONSTRUCTION SEQUENCE

- INSTALL SHAKE DOWN DEVICE AT ENTRY LOCATIONS.
- CONSTRUCT ROCK CHECK DAM AT SITE STORMWATER OUTLET.
- INSTALL ALL ADDITIONAL SEDIMENT CONTROL DEVICES.
- CONSTRUCT DRAINAGE CHANNELS.
- CONSTRUCT STORMWATER PIPED NETWORK. ALL GULLY INLETS AND STORMWATER OUTLETS TO BE PROTECTED.
- CONSTRUCT WATER AND ELECTRICAL RETICULATION.
- CONSTRUCT ROADS.
- ALL AREAS OF DISTURBANCE OUTSIDE ROADWAY TO BE GRASS SEEDED AS DIRECTED ON COMPLETION OF WORKS AND 70% GRASS COVER AND APPROVAL BY COUNCIL. SEDIMENT BASIN TO BE REMOVED AND AREA TO BE CONVERTED TO DETENTION BASIN IN ACCORDANCE WITH APPROVED DRAWINGS.



SEDIMENT MANAGEMENT PROGRAM

- CLEARING**
 - EARTH BANK AND TABLE DRAIN TO BE CONSTRUCTED ALONG THE TOP OF THE EXISTING BATTER.
 - SEDIMENT FENCE, SAND BAGS, SEDIMENT BASINS AND EARTH RILLS TO BE ERECTED AS INDICATED OR REQUIRED.
 - EXISTING GRASSED AREAS TO BE KEPT WHERE POSSIBLE.
 - SHAKE DOWN/WASH DOWN BAY AT ENTRY/EXIT POINT AS REQUIRED BY COUNCIL OFFICER.
- EARTHWORKS**
 - SEDIMENT FENCES, SEDIMENT BASINS AND EARTH RILLS WITHIN ROADS TO BE ERECTED AS INDICATED OR REQUIRED.
- SEWER / ROOFWATER / STORMWATER / SERVICES**
 - EXCAVATED MATERIAL TO BE PLACED ON HIGH SIDE OF TRENCH AND TO PROTECT PIPE WORK AND DIRECT SURFACE MATERIAL AWAY FROM EXCAVATIONS.
 - TOPSOIL AND GRASS SEED AREAS IN ALLOTMENTS IMMEDIATELY AFTER COMPLETING THE SEWER AND ROOFWATER DRAINAGE CONSTRUCTION.
 - DEPRESS GROUND AROUND TEMPORARY FIELD INLETS TO CREATE SEDIMENT POND.
- STOCKPILE**
 - SEDIMENT FENCE TO BE ERECTED 5m FROM TOE OF BATTER ON LOW SIDE OF STOCKPILE.
- ROADWORKS**
 - SEDIMENT FENCES TO ALLOTMENTS TO BE ERECTED.
 - KERB INLET PROTECTION TO BE PROVIDED.
 - SAND BAGS SURROUND SAG GULLY PITS AS INDICATED.
- ALLOTMENTS**
 - MULCH AS DIRECTED AND TOPSOIL AND SEED ALLOTMENTS.
 - SEDIMENT FENCES TO ALLOTMENTS TO BE RE-ERECTED.
 - COVERS TO GULLY GRATES TO BE REMOVED IF THE SUPERINTENDENT INDICATES THE GRASS STRIKE IS SUFFICIENT.
 - ESTABLISHMENT OF 70% COVERAGE WITHIN 30 CALENDAR DAYS OF COMPLETION OF WORKS.
- MAINTENANCE PERIOD**
 - ALL ESC MEASURES SHALL BE INSPECTED AT LEAST DAILY (WHEN WORK IS OCCURRING ON SITE) OR WEEKLY (WHEN WORK IS NOT OCCURRING ON SITE) WITHIN 24 HOURS OF EXPECTED RAIN, AND WITHIN 18 HOURS OF A RAINFALL EVENT
 - ALL ESC MEASURES SHALL BE MAINTAINED THE SAME DAY WHEN THE CAPACITY OF THE ESC MEASURE REDUCES BY 30%.

PLANS AND DOCUMENTS
referred to in the
SDA APPROVAL



SDA approval: AP2024/001

		SURVEY DATA		BEAUDESERT & BOONAH CRANES		ESC NOTES - SHEET 03		P0 Box 554 Beaudesert QLD 4285		 CIVIL ENVIRONMENTAL PROJECT MANAGEMENT		
		DATUM		48 KOOROOMBA DRIVE, MT ALFORD QLD 4310				(07) 55413500 www.acsengineers.com.au				
4	INCLUSION OF NOTES FOR PROPERTY ACCESS	MLS	11/06/24	MAP GRID					DRAWING NUMBER		REVISION	
3	INCLUSION OF VEGETATION BUFFER, RELOCATED DRAIN	MLS	22/04/24	HEIGHT ORIGIN	BEAUDESERT & BOONAH CRANES		ENGINEERING CERTIFICATION (RPEQ)		# FIELD NAME SIGNATURE DATE		4	
2	FOR APPROVAL	NJF	10/04/24	SURVEY BOOKS								
1	PRELIMINARY	NJF	28/09/23		149 SANDY CREEK ROAD, BROMELTON QLD 4285		13697	CIVIL	S. SHAY		30/01/25	ACS-230068-GEN-13
REVISION/DETAILS		DWN	DATE	DES	DATE							

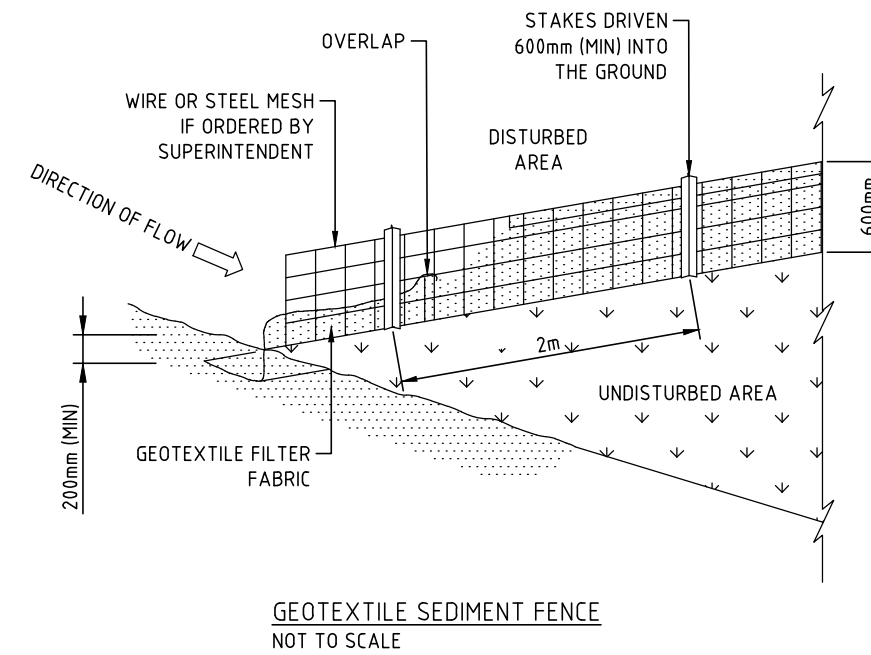
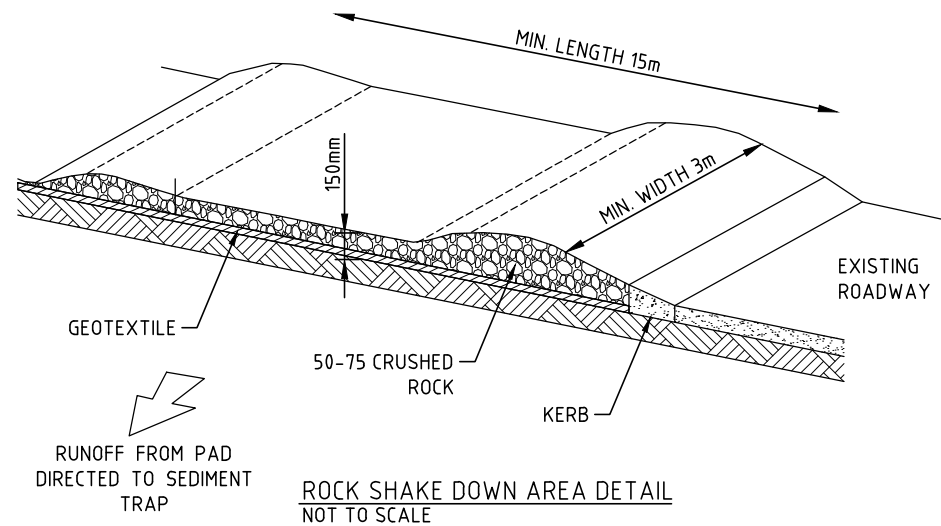
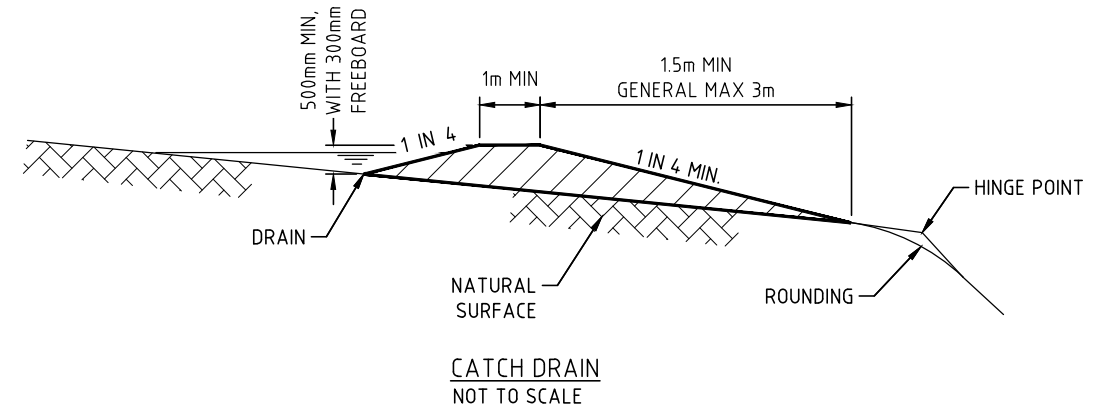
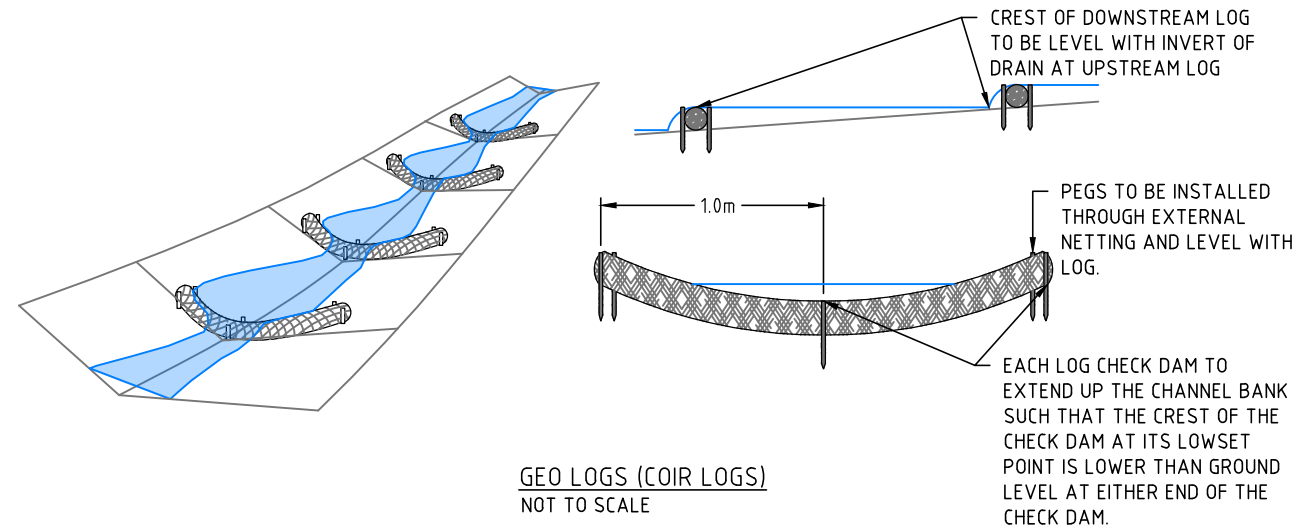





PLANS AND DOCUMENTS
referred to in the
SDA APPROVAL



SDA approval: AP2024/001

		SURVEY DATA		BEAUDESERT & BOONAH CRANES		ESC DETAILS			P0 Box 554 Beaudesert QLD 4285 (07) 55413500 www.acsengineers.com.au		ACS Engineers CIVIL ENVIRONMENTAL PROJECT MANAGEMENT
			DATUM	48 KOOROOMBA DRIVE, MT ALFORD QLD 4310					DRAWING NUMBER		
4	INCLUSION OF NOTES FOR PROPERTY ACCESS	MLS	11/06/24	MAP GRID					ACS-230068-GEN-14		4
3	INCLUSION OF VEGETATION BUFFER, RELOCATED DRAIN	MLS	22/04/24	HEIGHT ORIGIN							
2	FOR APPROVAL	NJF	10/04/24	SURVEY BOOKS							
1	PRELIMINARY	NJF	28/09/23								
REVISION/DETAILS				DWN	DATE	DES	DATE				
FILE: C:\1205\DATA\ACSS\YN\230068 BEAUDESERT & BOONAH CRANES - 149 SANDY CREEK ROAD, BROMELTON_681\DESIGN\DRAWING FILES\ACS-230068-GEN.DWG				PLOT TIME: 30/11/2025 - 8:18AM		BY USER: NICHOLAS FALVEY					
				BEAUDESERT & BOONAH CRANES		#	FIELD	NAME	SIGNATURE	DATE	
				149 SANDY CREEK ROAD, BROMELTON QLD 4285		13697	CIVIL	S. SHAY		30/01/25	

LEGEND

-  CATCH DRAIN
-  GEO LOG (COIR LOG)
-  SEDIMENT FENCE
-  ROCK PAD



PLANS AND DOCUMENTS referred to in the SDA APPROVAL

SDA approval: AP2024/001

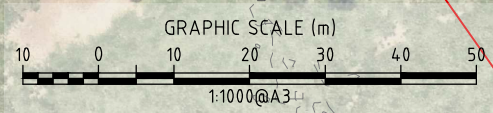
				SURVEY DATA	BEAUDESERT & BOONAH CRANES	ESC LAYOUT PLAN			PO Box 554 Beaudesert QLD 4285 (07) 5541 3500 www.acsengineers.com.au	 CIVIL ENVIRONMENTAL PROJECT MANAGEMENT			
5	ACCESS LOCATION ADJUSTED AS PER RFI	NJF	30/01/25	DATUM	48 KOOROOMBA DRIVE, MT ALFORD QLD 4310	BEAUDESERT & BOONAH CRANES 149 SANDY CREEK ROAD, BROMELTON QLD 4285			ENGINEERING CERTIFICATION (RPEQ)			DRAWING NUMBER	REVISION
4	INCLUSION OF NOTES FOR PROPERTY ACCESS	MLS	11/06/24	MAP GRID	# FIELD NAME SIGNATURE DATE				ACS-230068-GEN-15		30/01/25	5	
3	INCLUSION OF VEGETATION BUFFER, RELOCATED DRAIN	MLS	22/04/24	HEIGHT ORIGIN	13697	CIVIL	S. SHAY	1:1000@A3					
2	FOR APPROVAL	NJF	10/04/24	SURVEY BOOKS	REVISION								
1	PRELIMINARY	NJF	28/09/23	DATE	DATE		DATE		DATE				

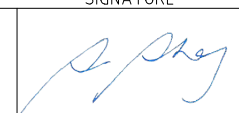

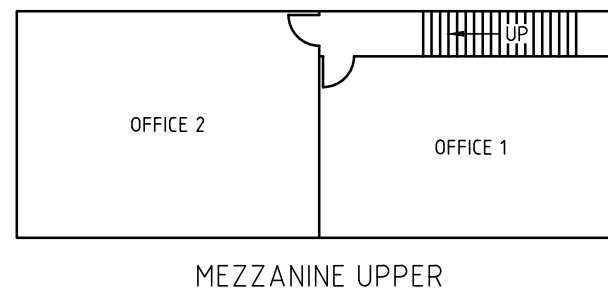
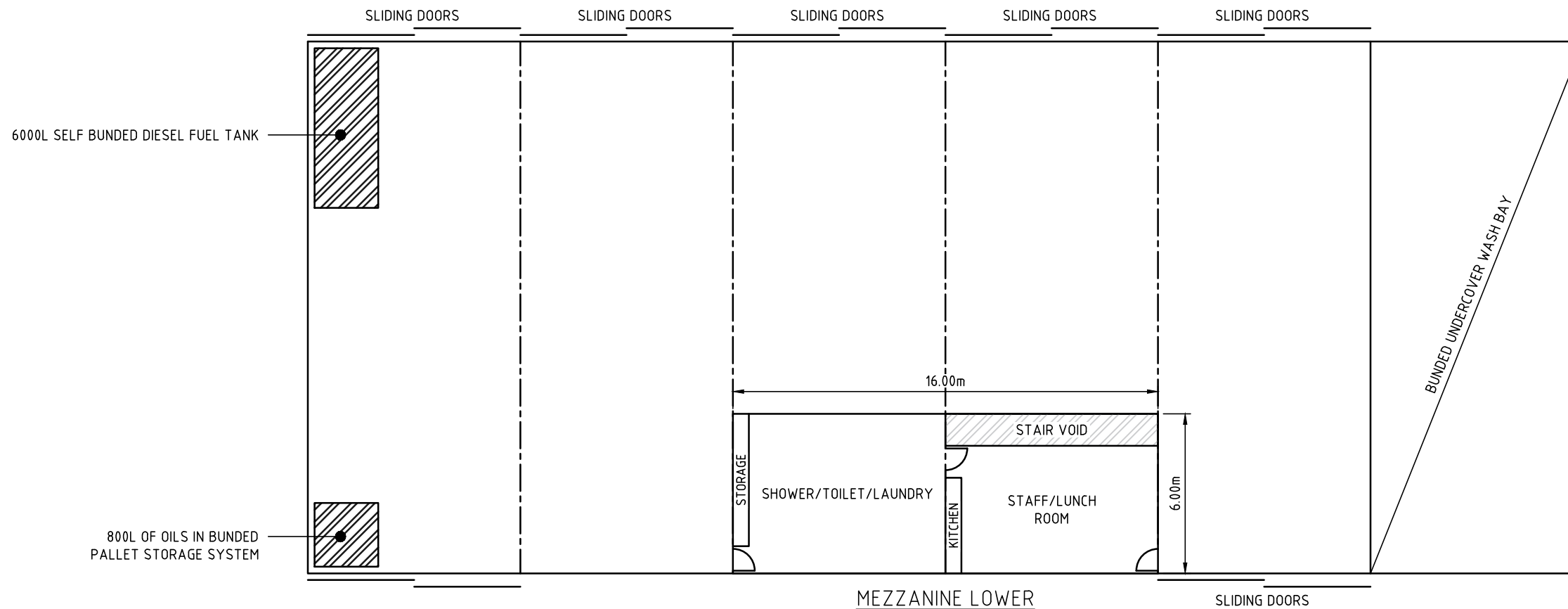
PLANS AND DOCUMENTS
referred to in the
SDA APPROVAL

Queensland
Government

SDA approval: AP2024/001

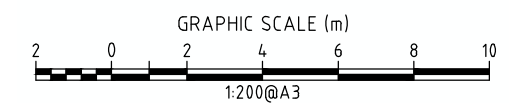

				SURVEY DATA		BEAUDESERT & BOONAH CRANES		BUILDING LAYOUT PLAN		PO Box 554 Beaudesert QLD 4285		 ACS Engineers CIVIL ENVIRONMENTAL PROJECT MANAGEMENT					
				DATUM		48 KOOROOMBA DRIVE, MT ALFORD QLD 4310				ENGINEERING CERTIFICATION (RPEQ)				DRAWING NUMBER		REVISION	
				MAP GRID				#		FIELD		NAME		SIGNATURE		DATE	
				HEIGHT ORIGIN				13697		CIVIL		S. SHAY				30/01/25	
				SURVEY BOOKS				BEAUDESERT & BOONAH CRANES								ACS-230068-GEN-16	
1		FOR APPROVAL		NJF		21/10/24		149 SANDY CREEK ROAD, BROMELTON QLD 4285								1	
		REVISION/DETAILS		DWN		DATE		DES		DATE							

FILE: C:\1205\DATA\ACSS\YN\230068 BEAUDESERT & BOONAH CRANES - 149 SANDY CREEK ROAD, BROMELTON_68\DESIGN\DRAWING FILES\ACS-230068-GEN.DWG PLOT TIME: 30/11/2025 - 8:18AM BY USER: NICHOLASFALVEY

SCOPE OF WORKS.....

THE SCOPE OF LANDSCAPE WORKS INCLUDES THE REMOVAL OF ANY EXISTING VEGETATION IF INDICATED AS WELL AS THE PREPARATION AND CULTIVATION OF SUBGRADES PRIOR TO TOPSOILING, FINE GRADING AFTER BULK OR MINOR EXCAVATION WORKS, THE SUPPLY AND INSTALLATION OF TOPSOILS, MULCH AND THE INSTALLATION AND MAINTENANCE (THROUGHOUT THE CONSOLIDATION AND MAINTENANCE PERIOD) OF ALL PLANT MATERIAL AND TURFED AREAS.

HARDSCAPE WORKS WILL INCLUDE BUT NOT BE LIMITED TO THE SUPPLY AND CONSTRUCTION OF RETAINING WALLS, PEDESTRIAN PATHWAYS, PAVING/TILING, PLANTER BOXES AND TIMBER DECKING IF AND WHERE INDICATED.

STRIPING & STOCKPILING OF TOPSOIL

PRIOR TO COMMENCEMENT OF EXCAVATION, STRIP TOPSOIL WITHIN THE LIMITS OF EARTHWORKS TO PROVIDE FOR LATER REUSE AS SPECIFIED. ENSURE ALL TOPSOIL IS REMOVED FROM AREAS TO BE COVERED BY PAVING AND STRUCTURES. ALSO STRIP TOPSOIL FROM THE LIMITS OF CLEARING FOR ANY UNDERGROUND SERVICES BEYOND THE LIMITS OF EXCAVATION, UNLESS OTHERWISE DIRECTED. THE DEPTH OF STRIPPING SHALL BE TO THE BOTTOM OF ANY EXISTING ROOTZONE. AVOID CONTAMINATION BY ANY OTHER MATERIAL.

SUBGRADE PREPARATION

ALL BULK EARTHWORKS AND ROUGH FORMING OF THE SUBGRADE TO THE UNDERSIDE OF THE TOPSOIL SHALL BE DONE BY OTHERS. THE LANDSCAPE CONTRACTOR SHALL BE RESPONSIBLE FOR THE FINAL TRIMMING OF THE SUBGRADE TO ACHIEVE THE REQUIRED DEPTH FOR TURF AND SHRUB BEDS BELOW THE FINISHED SURFACE LEVELS. PREPARE THE SUBGRADE PRIOR TO THE SPREADING OF TOPSOIL AS SPECIFIED BELOW AND ALLOW FOR CLEARING AND REMOVAL OF STONES AND BUILDING DEBRIS BROUGHT TO THE SURFACE DURING CULTIVATION. TRIM ALL SURFACES TO SPECIFIED SHAPE AFTER CULTIVATION.

1. TURF AREAS - CULTIVATE AREAS TO BE TURFED SO THAT THE SURFACE SOIL CAN BE WORKED FREELY TO A MINIMUM DEPTH OF 150MM AND TO CORRECT DRAINAGE POINTS (INSTALLED BY OTHERS). REMOVE ANY PERENNIAL WEEDS AND RUBBISH FROM THE SURFACE AFTER CULTIVATION.

2. PLANTING AREAS - EXCAVATE AND REMOVE CLAY SUBSOIL, BUILDER'S DEBRIS (PARTICULARLY CONCRETE/CEMENT) AND OTHER DELETERIOUS MATERIAL FROM THE PLANTING BED TO A MINIMUM DEPTH OF 300MM BELOW THE FINISHED SURFACE LEVEL OF TOPSOIL UNLESS OTHERWISE SPECIFIED. SHAPE THE SUBGRADE TO FALL TO ALL SUBSOIL DRAINS AS PREVIOUSLY MENTIONED. PRIOR TO BACKFILLING, ENSURE THE BASE OF PLANTING BEDS ARE 'BROKEN UP' TO A MINIMUM DEPTH OF 150MM AND SUPPLY AND SPREAD 'CLAY BREAKING' SOIL ADDITIVES IN ACCORDANCE WITH THE MANUFACTURERS SPECIFICATIONS.

TOPSOIL

SOIL TEXTURES (ACCEPTABLE PH IN THE RANGE OF 6.0 - 7.0)

WHERE DETAILED, TREAT AREAS TO BE LANDSCAPED WITH A SUITABLE HERBICIDE PRIOR TO COMMENCING ANY OTHER TREATMENT. PRIOR TO SPREADING TOPSOIL, THE AREA IS TO BE INSPECTED AND APPROVED BY THE SUPERVISING LANDSCAPE CONTRACTOR.

THE TEXTURE OF ANY IMPORTED SANDY LOAM TOPSOIL SHALL BE LIGHT TO MEDIUM (CAPABLE OF BEING HANDLED WHEN MOIST) BUT LACKING COHESION SO THAT IT WILL FALL APART WHEN DRY.

ALL IMPORTED SOILS, BOTH TURF AND GARDEN, SHALL BE FREE OF WEEDS (PARTICULARLY NUTGRASS). ANY SOIL CONTAINING A HIGH LEVEL OF SALTS, HIGH LEVELS OF CLAY PARTICLES, LOW LEVELS OF CARBON OR ANY OTHER EXTREMES WHICH MAY BE CONSIDERED HAZARDOUS OR TOXIC WILL BE REJECTED PRIOR TO PLACEMENT. SOILS WITH NUTRITIONAL OR TRACE ELEMENT DEFICIENCIES MAY BE ACCEPTED BUT SHALL BE AMENDED WITH THE USE OF SUITABLE SOIL ADDITIVES SUCH AS COMPOST. SOILS NOT CONFORMING TO SUITABLE PARTICLE SIZE DISTRIBUTION OR CONTAINING ANY OF THE AFORE-MENTIONED PROBLEMS MUST BE REJECTED. ANY COSTS INCURRED BY THE REJECTION OF SOILS SHALL BE NEGOTIATED BETWEEN THE LANDSCAPE CONTRACTOR AND THE LANDSCAPE MATERIALS SUPPLIER.

THE USE OF WATER RETENTION PRODUCTS IS HIGHLY ADVISED AND SHOULD BE MIXED INTO ANY IMPORTED SOILS PRIOR TO PLACEMENT. SUCH PRODUCTS SHALL BE UTILISED IN ACCORDANCE WITH THE MANUFACTURERS DIRECTIONS.

ALL FINISHED SOIL SURFACING, INCLUDING MOUNDING WHERE INDICATED, SHALL BE SMOOTH AND FREE OF DEBRIS IN PREPARATION FOR TURFING OR PLANTING. ALL TURF AND PLANTING AREAS SHALL BE LIGHTLY COMPACTED TO 85% MDD UNLESS OTHERWISE SPECIFIED.

THE FINISHED SURFACE LEVEL OF TOPSOIL IN TURF AREAS SHALL FINISH AT A SURFACE LEVEL THAT ACCOMMODATES TURF SOD THICKNESS ALLOWING A FLUSH FINISH WITH ADJACENT HARDSTAND SURFACES. THE FINISHED SURFACE LEVEL OF SOILS FOR SHRUB BEDS SHALL FINISH, WHEN THE SPECIFIED DEPTH OF MULCH IS PLACED AND SPREAD, 25MM BELOW ADJACENT HARDSTAND FINISHES AND TURF SODS.

DRAINAGE

ALL SUBSOIL DRAINAGE OR SURFACE DRAINAGE IS TO BE INSTALLED AS PER THE ENGINEER'S DETAIL AND SPECIFICATION. A LICENCED PLUMBER OR DRAINER SHOULD BE CONTRACTED UNLESS THE LANDSCAPE CONTRACTOR HOLDS RELEVANT AND CURRENT LICENCING TO INSTALL DRAINAGE.

MULCH

SUPPLY AND PLACE A HIGH QUALITY GARDEN MULCH TO ALL GARDEN BED AREAS AS INDICATED. ALL MULCHING SHALL BE TO A MINIMUM DEPTH OF 75MM AND BE FREE OF ANY FOREIGN MATTER. MULCH MUST BE REMOVED FROM AROUND THE STEMS OF PLANT SPECIES AND TREES IN SHRUB BEDS TO AVOID COLLAR ROT AND IS TO BE SPREAD TO AN EVEN FINISH OF 25MM BELOW ADJACENT HARDSTAND SURFACE OR TURF. SUITABLE MULCHES INCLUDE: GRADED HOOP PINE, BARK FINES OR CYPRESS PINE UNLESS OTHERWISE INDICATED. THE USE OF WEED MATTING IS FORBIDDEN AS IT STIFLES AIR CIRCULATION WITHIN THE SOIL STRUCTURE RESULTING IN POOR PLANT HEALTH AND COMPACTION.

TURF

SUPPLY AND PLACE SELECTED A GRADE QUALITY TURF. WHERE SYNTHETIC TURF HAS BEEN SPECIFIED, INSTALLATION WILL BE AS PER MANUFACTURER'S SPECIFICATION.

THE LAYING OF TURF SODS SHOULD BE COMPLETED WITHIN 24 HOURS OF TURF BEING 'CUT' FROM THE TURF SUPPLIER. LAYING PROCEDURES SHOULD BE AS FOLLOWS: MOISTEN PREPARED SURFACE BEFORE PLACEMENT OF SODS. LAY A HEADER COURSE AROUND THE PERIMETER OF THE AREA BEING TURFED THEN LAY WITH STAGGERED JOINTS CLOSELY BUTTED TOGETHER. ONCE FULLY LAID, MOISTEN TURF SURFACE AND ROLL TO ASSIST IN BOTH SOD COHESION WITH UNDERTURF SOILS AND TO PROVIDE A LEVEL LAWN. NEATLY TRIM SODS TO ALL EDGE PROFILES AND TOPDRESS ANY AREAS WHERE GAPS MAY BE PRESENT. PROTECT NEW TURF FROM VEHICULAR OR PEDESTRIAN TRAFFIC UNTIL TURF HAS LAID ROOTS AND BECOME ESTABLISHED (APPROX. 2 WEEKS).

AFTER 2 WEEKS OF ESTABLISHMENT, REPLACE ANY SODS THAT HAVE NOT 'TAKEN'. THE FIRST CUT AND SUBSEQUENT MOWING DURING THE CONSOLIDATION AND MAINTENANCE PERIOD SHALL BE CARRIED OUT IN REGULAR INTERVALS AT A MOWING HEIGHT RANGE OF NO LESS THAN 25MM - 35MM.

PLANTING

1. SUPPLY OF PLANT MATERIAL - WHERE PLANTS ARE SPECIFIED TO BE SUPPLIED, PLACE ORDER WITHIN 30 DAYS OF NOTICE OF ACCEPTANCE OF TENDER FOR THE REQUIRED PLANT MATERIALS ACCORDING TO THE SPECIES, VARIETIES, SIZES AND QUANTITIES AS LISTED IN THE PROPOSED PLANT SCHEDULE. IN THE EVENT OF PROPOSED PLANT SPECIES NOT BEING AVAILABLE AT TIME OF ORDERING, PLEASE CONTACT STUDIO8 TO ADVISE OF EITHER A PROPOSED SPECIES SUBSTITUTION OR CONTAINER SIZE VARIATION. SUBSTITUTIONS OF SPECIES WILL NOT BE PERMITTED IN CASES WHERE THE LANDSCAPE CONTRACTOR HAS NOT COMPLIED WITH THE ABOVE REQUIREMENTS.

2. INSPECTION - ALL PLANT MATERIAL SHALL BE AVAILABLE FOR INSPECTION BY STUDIO8 AT ANY REASONABLE TIME. PLANTS SHALL BE WELL-GROWN, EITHER SUN OR SHADE TOLERANT AS PER THE PLANTING AREA REQUIRES. NOT ROOTBALLED AND BE FREE OF ALL PEST AND DISEASES.

3. PLANTING - FOR INDIVIDUAL OR MASS PLANTING, INDIVIDUAL HOLES SHALL BE EXCAVATED TO A SIZE THAT ALLOWS 100MM BACKFILLING OF ORGANIC BASED SOILS AROUND THE ROOT SYSTEM FOR SHRUBS, GRASSES AND GROUNDCOVERS AND 300MM FOR SEMI-MATURE AND MATURE TREES AND PALMS.

PLANTS SHALL BE PLACED IN THE CENTRE OF THE HOLE AND SET PLUMB AT SUCH A LEVEL THAT AFTER SETTLING AND FIRING, A NORMAL AND NATURAL RELATIONSHIP OF THE PLANT WITH THE GROUND SURFACE IS ACHIEVED. PLANT ROOT SYSTEMS MUST BE MOIST AT THE TIME OF REMOVAL FROM THE CONTAINERS. MOISTENING OF THE EXCAVATED HOLE PRIOR TO PLANT PLACEMENT WILL ALSO ASSIST IN AVOIDING MOISTURE WITHDRAWAL FROM THE PLANT SPECIMEN FROM SURROUNDING 'DRYER' SOILS.

4. FERTILISING - OVER-FERTILISATION OF NEW PLANT SPECIES IS DETRIMENTAL TO THE HEALTHY ESTABLISHMENT OF THE PLANT. PLANT SPECIES PURCHASED FROM CREDIBLE PLANT SUPPLIERS WILL CONTAIN ADEQUATE SLOW RELEASE FERTILISERS AND THEREFORE ADDITIONAL FERTILISING WILL NOT BE REQUIRED AT TIME OF PLANTING. HOWEVER, A SLOW RELEASE BALANCED FERTILISER WILL BE REQUIRED BEFORE THE EXPIRATION OF THE CONSOLIDATION AND MAINTENANCE PERIOD. SUCH FERTILISERS SHALL BE ADMINISTERED ACCORDING TO THE NUTRITIONAL NEEDS OF THE PLANT SPECIMEN EG. 60G FOR SHRUBS AND GROUNDCOVERS AND 300G FOR SEMI AND MATURE TREE SPECIES. FOR PLANT SPECIES REQUIRING A PARTICULAR TYPE OF FERTILISER EG. LOW PHOSPHORUS TYPES FOR NATIVE PLANT SPECIES, SUCH FERTILISER SUPPLY AND DISTRIBUTION OVER-RIDES THE USE OF 'GENERAL' BALANCED NPK TYPES.

IRRIGATION

ENSURE THAT ALL PLANT SPECIES AND TURFED AREAS RECEIVE AN ADEQUATE AMOUNT OF WATER IMMEDIATELY AFTER PLACEMENT AND AT SUCH TIMES DURING THE CONTRACT PERIOD TO ENSURE A HEALTHY ESTABLISHMENT FREE OF WATER STRESS.

A FULLY AUTOMATED IRRIGATION SYSTEM IS HIGHLY RECOMMENDED WITH WATER BEING DRAWN FROM ON-SITE WATER TANKS IF AVAILABLE IN PREFERENCE TO COUNCIL'S POTABLE WATER SUPPLY. A TESTABLE BACKFLOW DEVICE SHALL BE INSTALLED IN ACCORDANCE WITH AUSTRALIAN STANDARDS AND COUNCIL'S REQUIREMENTS.

WHERE FREESTANDING PLANTERS OR PLANTERBOXES HAVE BEEN SPECIFIED, INSTALLATION OF A DRIP IRRIGATION SYSTEM IS REQUIRED.

CONSOLIDATION AND MAINTENANCE PERIOD

THE LANDSCAPE CONTRACTOR SHALL CONSOLIDATE AND MAINTAIN THE LANDSCAPE FOR A PERIOD OF 12 WEEKS FROM THE DATE OF PRACTICAL COMPLETION. DURING THIS PERIOD THE CONTRACTOR SHALL MAKE GOOD ALL DEFECTS, BOTH HARDSCAPE AND SOFTSCAPE, WHICH MAY OCCUR. ESTABLISHMENT AND MAINTENANCE SHALL INCLUDE THE CARE AND MAINTENANCE OF THE LANDSCAPED AND TURFED AREAS BY ACCEPTED HORTICULTURAL BEST PRACTICES BY FORMALLY QUALIFIED AND COMPETENT STAFF.

THIS SHALL INCLUDE BUT NOT BE LIMITED TO: REPLACEMENT OF FAILED PLANT/TURF SPECIES, GENERAL WATERING, TURF AND GARDEN FERTILISING, WEED AND DISEASE CONTROL, LITTER AND DEBRIS REMOVAL, TOPDRESSING OF TURFED AREAS, LAWN MAINTENANCE (MOWING/EDGING/WEED & PEST CONTROL), ADDITIONAL SOILS ADDED WHERE SUBSIDENCE HAS OCCURRED, PRUNING/HEDGE ESTABLISHMENT, STAKING/GUYING TREE SPECIES WHERE REQUIRED, SCHEDULED IRRIGATION SYSTEM TESTING AND REPAIRS AS/IF REQUIRED AND REPAIR OF HARDSCAPE ELEMENTS AS/IF REQUIRED.

LOSS OF PLANT/TURF SPECIES NOT DIRECTLY CAUSED BY THE LANDSCAPE CONTRACTOR (OR STAFF) OR VANDALISM OF ANY ASPECT OF THE LANDSCAPE INCLUDING HARDSCAPE ELEMENTS BY 'OTHER' ONSITE CONTRACTORS OR THE PUBLIC SHALL NOT BE COVERED UNDER THE CONSOLIDATION AND MAINTENANCE CONTRACT. SUCH ISSUES WILL NEED TO BE REPORTED TO THE CLIENT OR AGENT AND A SUITABLE COURSE OF ACTION TAKEN.

AUSTRALIAN STANDARDS

- ALL EXISTING TREES SHOWN TO BE TO BE RETAINED SHALL BE IN ACCORDANCE WITH AUSTRALIAN STANDARD AS4970:2009 PROTECTION OF TREES ON DEVELOPMENT SITES
- MULCH TO BE IN ACCORDANCE WITH AS4454:2012 COMPOSTS, SOIL CONDITIONERS & MULCHES
- TURF SPECIES (INCLUDING VERGE TURF REPLACEMENT IF DAMAGE OCCURS TO BE IN ACCORDANCE WITH AS 5181:2017 USE AND INSTALLATION OF TURF AS AN EROSION, NUTRIENT AND SEDIMENT CONTROL MEASURE

PLANS AND DOCUMENTS referred to in the SDA APPROVAL



SDA approval: AP2024/001



SITE KEY

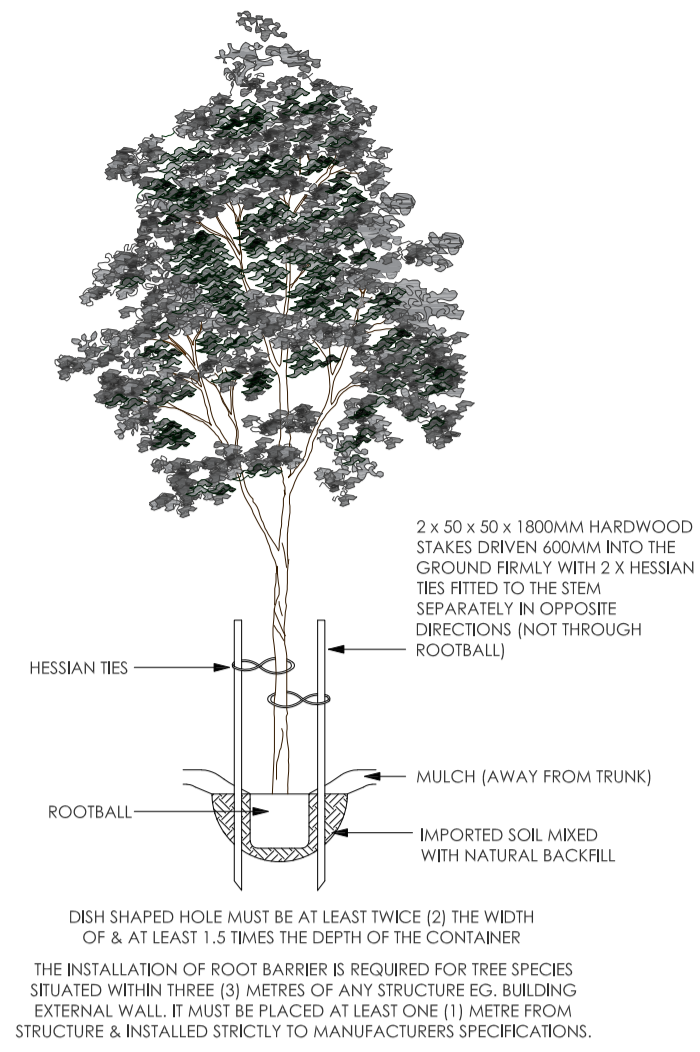
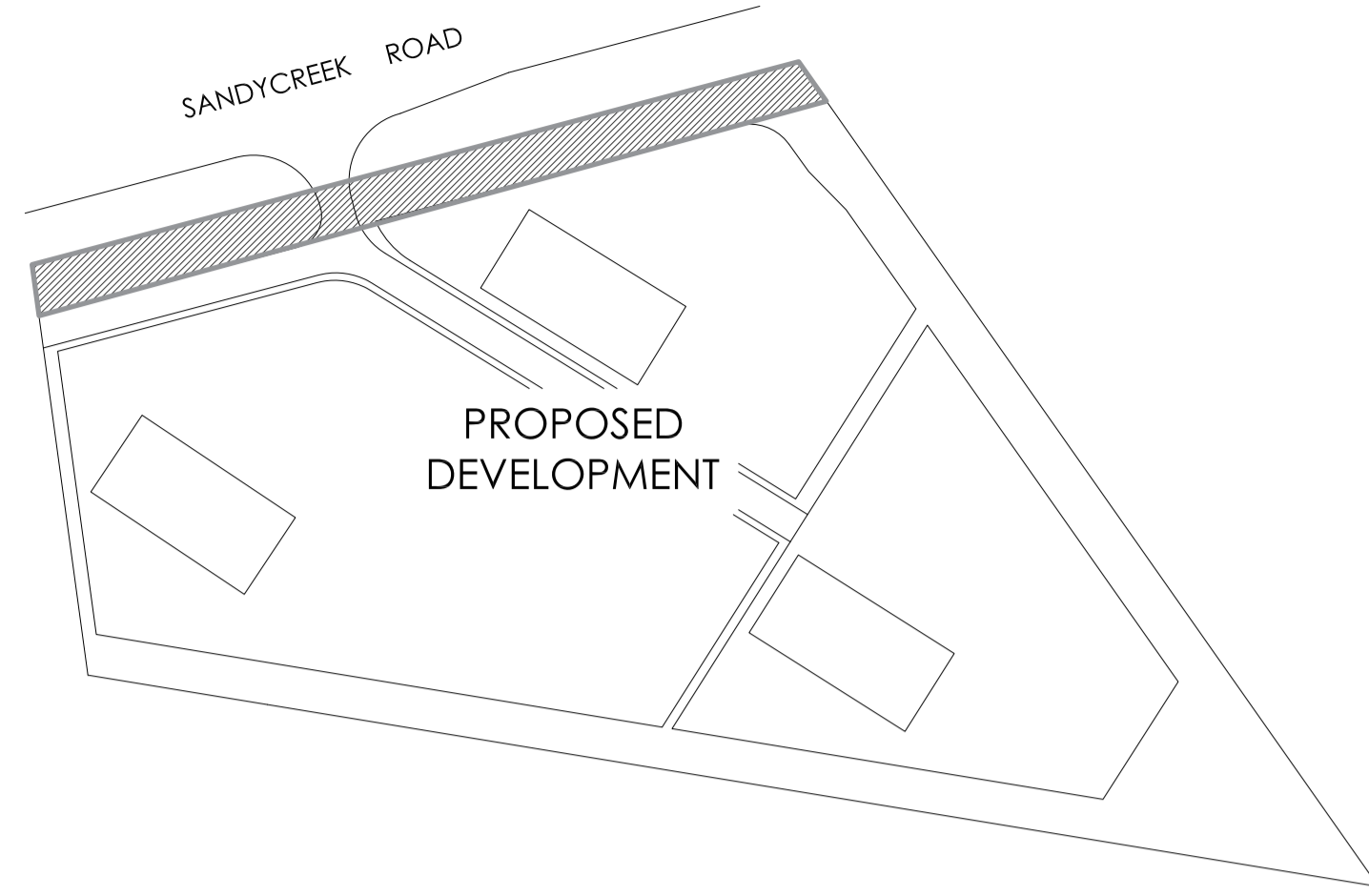

LD01 TREE PLANTING/STAKING DETAIL
SCALE NTS (INDICATIVE)

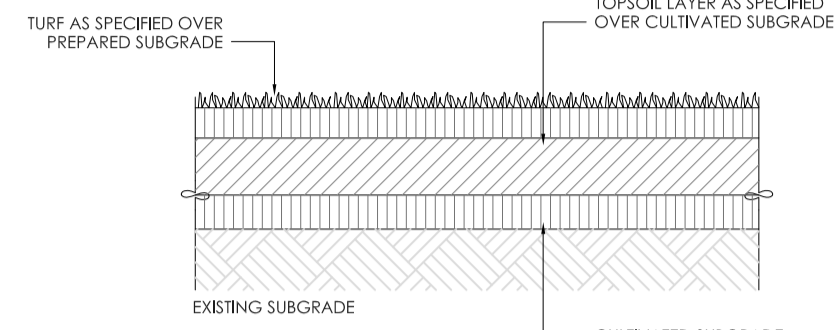

LD02 TURF DETAIL
SCALE NTS

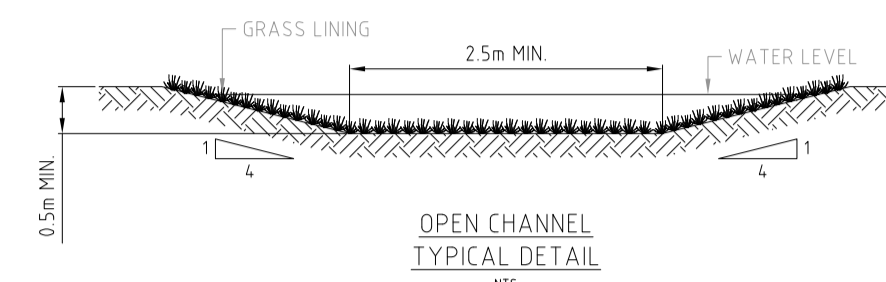

LD03 TURF SWALE DETAIL
SCALE NTS (TYPICAL) DETAIL BY OTHERS

PROPOSED PLANT SCHEDULE

	CODE	SPECIES	COMMON NAME	HEIGHT & SPREAD	POT SIZE	NO.
TREES	CUP ana	Cupaniopsis anacardioides	Tuckeroo	8 x 5	25 ltr	8
	TRI lau	Tristania laurina	Water Gum	8 x 5	25 ltr	8
	XAN chr	Xanthostemon cryanthus	Golden Pendas	8 x 5	25 ltr	10
SHRUBS	ACA fim	Acacia fimbriata	Fringed Wattle	3 x 3	200mm	11
	BAN eri	Banksia ericifolia	Heath Leafed Banksia	2 x 2	200mm	13
	CAL sal	Calistemon salignus	Willow Bottlebrush	3 x 2	200mm	2
	LEP pet	Leptospermum petersonii	Lemon Scented T-Tree	1.5 x 1.5	200mm	26
	MEL cla	Melaleuca cv	Claret Tops	1.5 x 1.5	200mm	26
	SYZ aus	Syzygium australe	Bush Xmas	4 x 3	200mm	22
OTHER	SYZ pan	Syzygium paniculatum	Magenta Cherry	4 x 3	200mm	26
	DOR exc	Doryanthes excelsa	Spear Lily	1.5 x 1.5	200mm	6
	HIB sca	Hibbertia scandens	Guinea Flower	prostrate	200mm	2
	LOM hys	Lomandra hystrix	River Mat Rush	.75 x .75	140mm	84

PLANS AND DOCUMENTS
referred to in the
SDA APPROVAL



SDA approval: AP2024/001

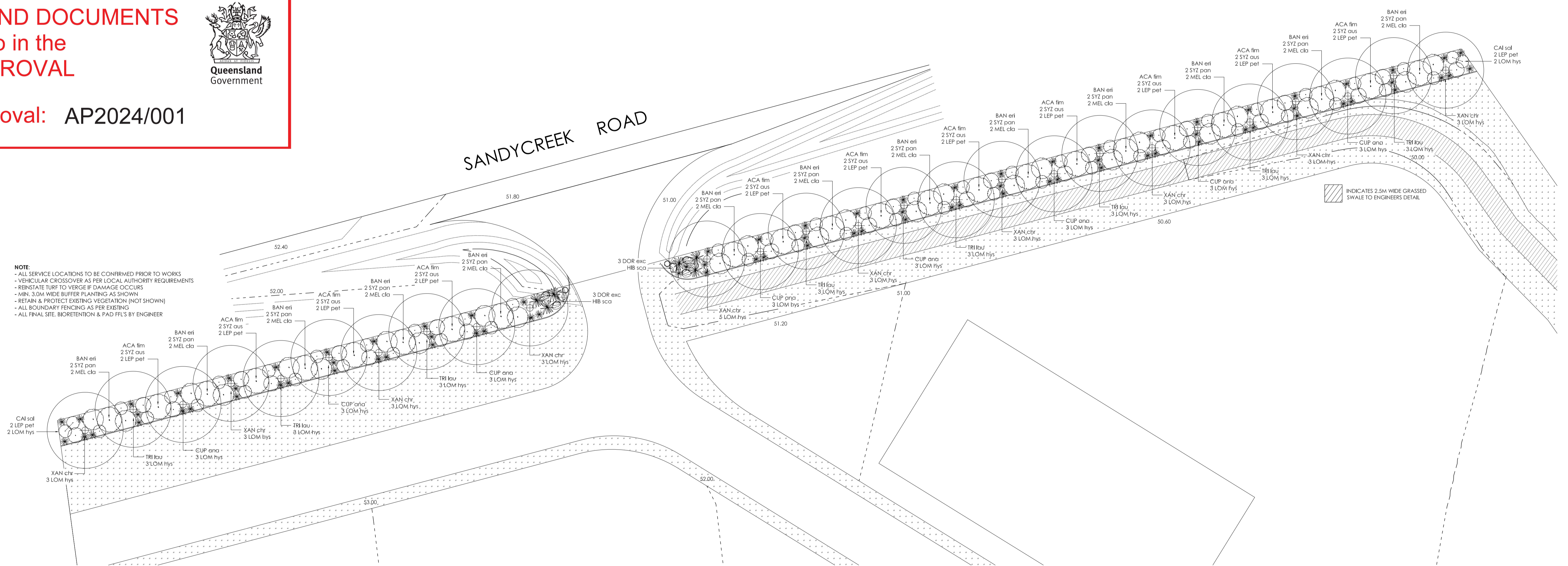

SANDY CREEK ROAD BROMELTON OPERATIONAL WORKS - PLANTING PLAN

PROPOSED TRANSPORT DEPOT DEVELOPMENT
149 SANDY CREEK ROAD BROMELTON Q - LOT 3 ON RP40309

DATE: 02.05.2024 DWG NO.: S8-1572LD ISSUE: A SHEET: 2 SCALE: 1:250 @ A1 DESIGNER: JAMIE SPEEDING
DIP: HORTICULTURE DIP: MANAGEMENT

© THIS DESIGN AND PLAN IS THE COPYRIGHT OF STUDIO8 AND CANNOT BE REPRODUCED WITHOUT WRITTEN PERMISSION

STUDIO8
CONCEPT+DESIGN

M: +61 434 047 903
E: jamie@studio8cd.com.au

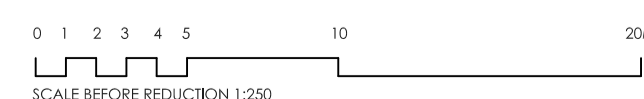
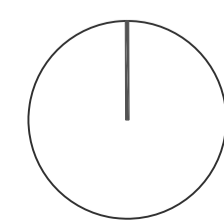

SITE KEY

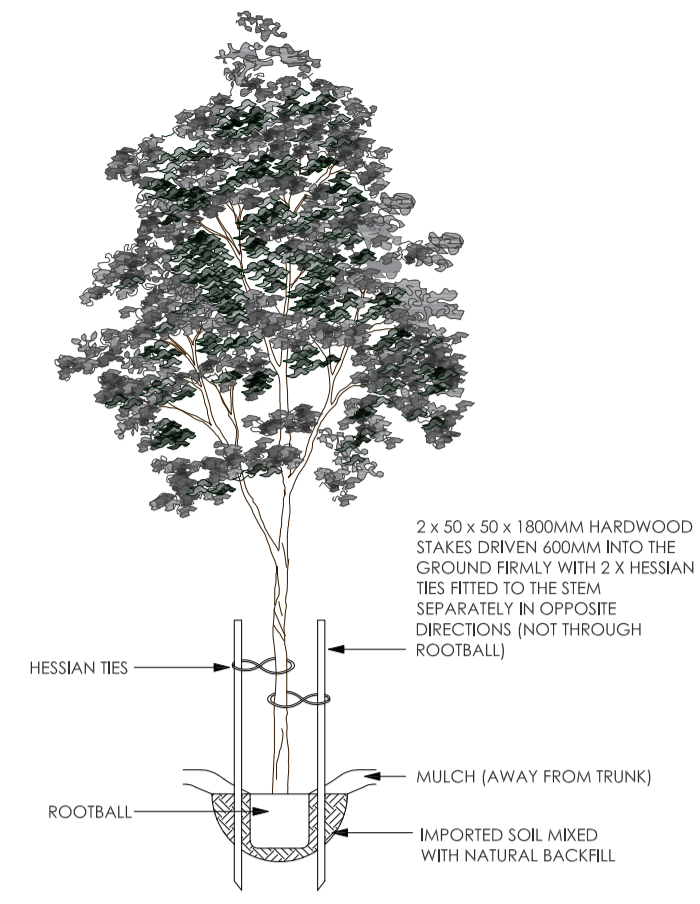
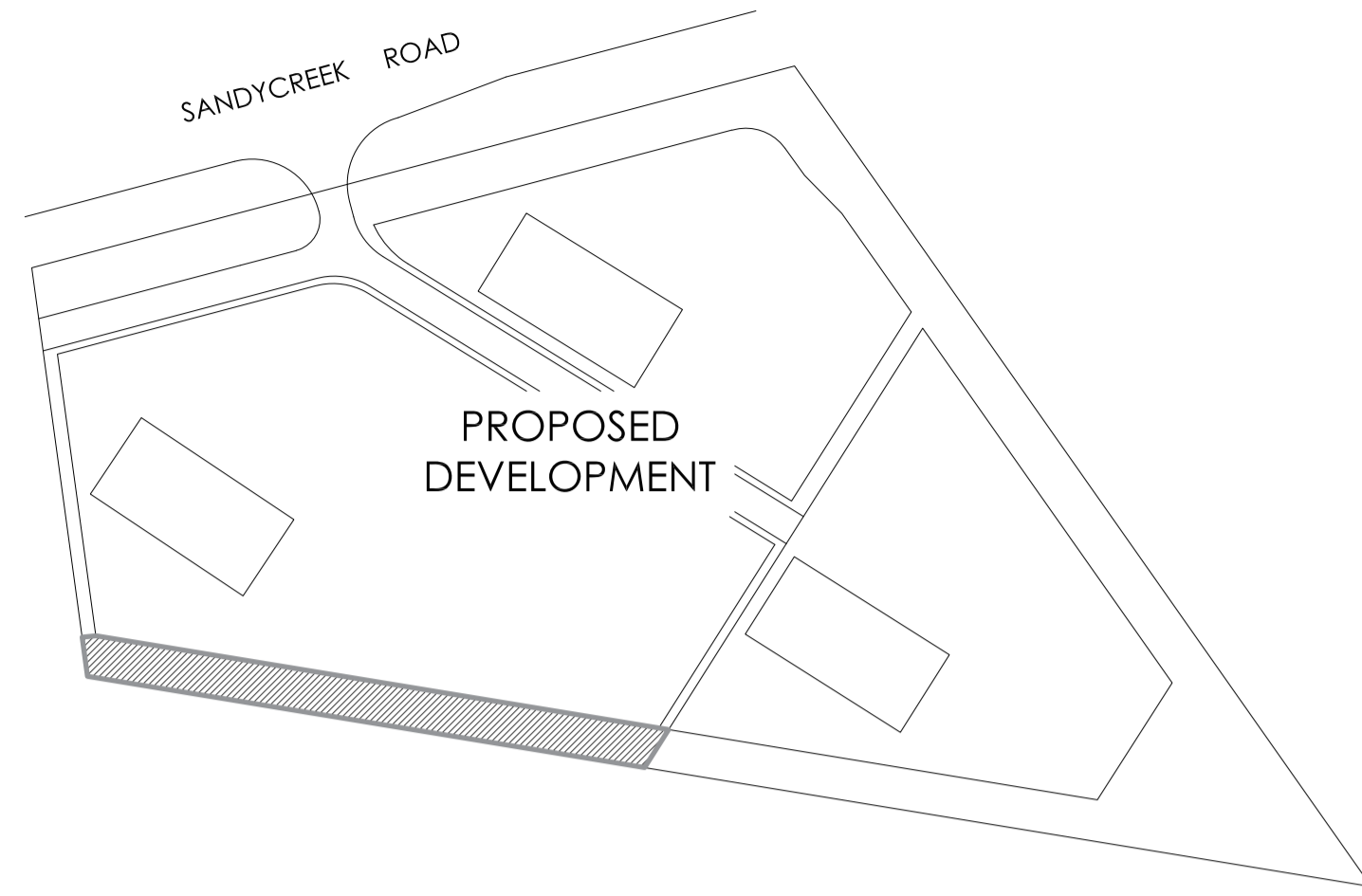

LD01 TREE PLANTING/STAKING DETAIL
SCALE NTS (INDICATIVE)

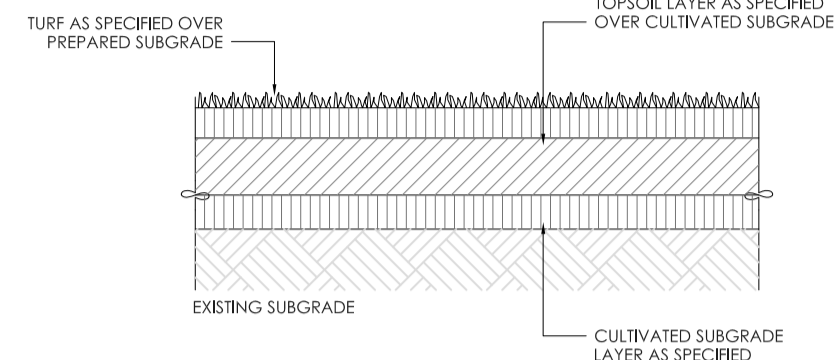

LD02 TURF DETAIL
SCALE NTS

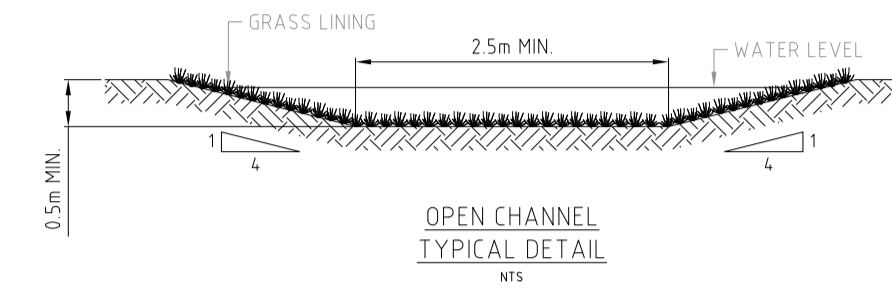

LD03 TURF SWALE DETAIL
SCALE NTS (TYPICAL) DETAIL BY OTHERS

PROPOSED PLANT SCHEDULE

	CODE	SPECIES	COMMON NAME	HEIGHT & SPREAD	POT SIZE	NO.
TREES	CUP ana	Cupaniopsis anacardioides	Tuckeroo	8 x 5	25 ltr	7
	TRI lau	Tristaniopsis laurina	Water Gum	8 x 5	25 ltr	7
	XAN chr	Xanthostemon cryanthus	Golden Pendas	8 x 5	25 ltr	7
SHRUBS	ACA fim	Acacia fimbriata	Fringed Wattle	3 x 3	200mm	10
	BAN eri	Banksia ericifolia	Heath Leafed Banksia	2 x 2	200mm	10
	CAL sal	Calistemon salignus	Willow Bottlebrush	3 x 2	200mm	1
	LEP pet	Leptospermum petersonii	Lemon Scented T-Tree	1.5 x 1.5	200mm	23
	MEL cla	Melaleuca cv	Claret Tops	1.5 x 1.5	200mm	20
	SYZ aus	Syzygium australe	Bush Xmas	4 x 3	200mm	20
SYZ pan	Syzygium paniculatum	Magenta Cherry	4 x 3	200mm	21	
OTHER	LOM hys	Lomandra hystrix	River Mat Rush	.75 x .75	140mm	65

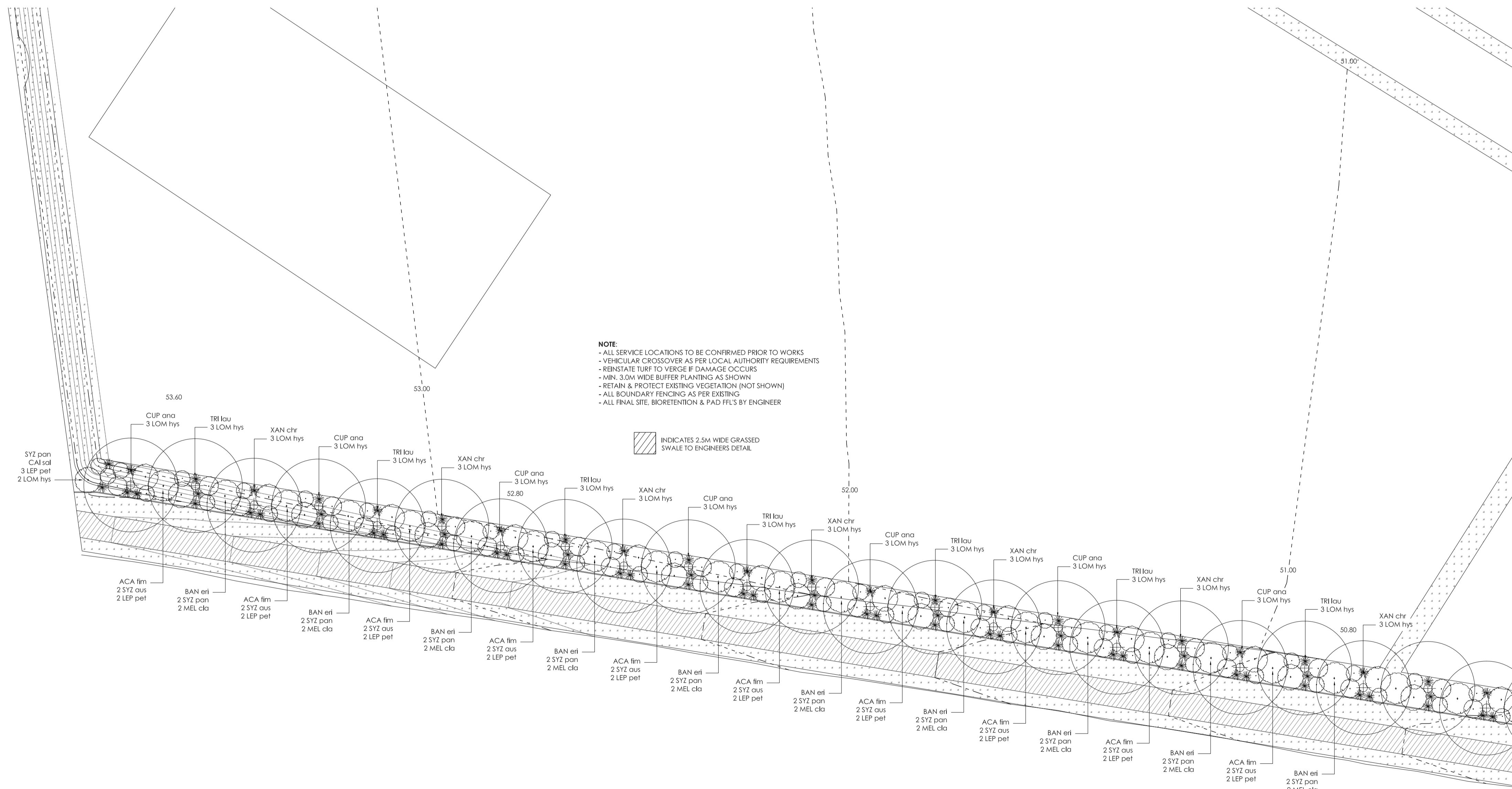

PLANS AND DOCUMENTS
referred to in the
SDA APPROVAL



SDA approval: AP2024/001

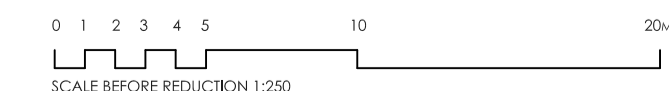
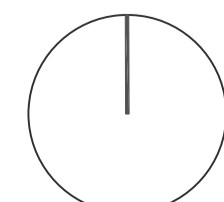

SITE KEY

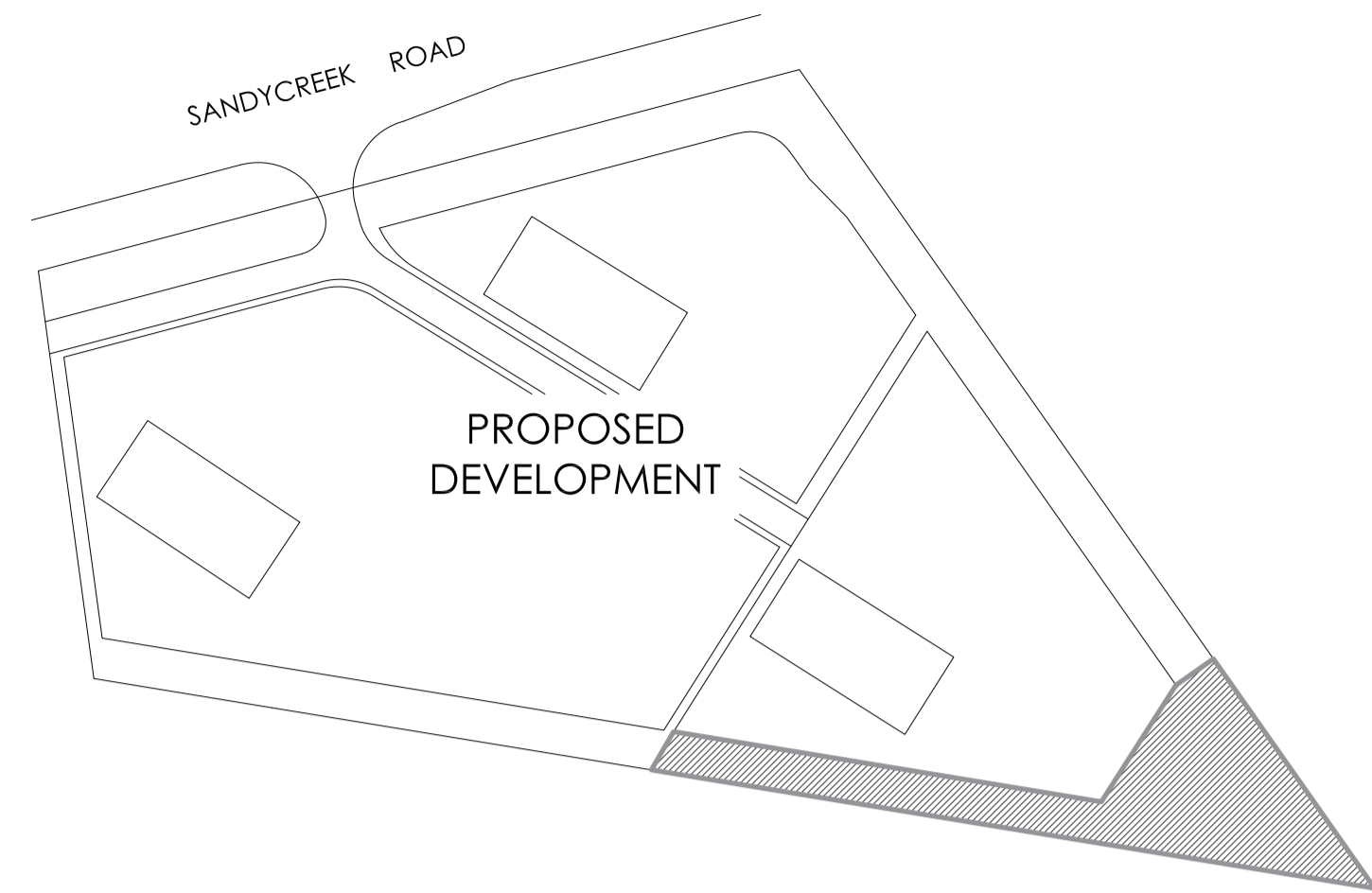

PROPOSED PLANT SCHEDULE

	CODE	SPECIES	COMMON NAME	HEIGHT & SPREAD	POT SIZE	NO.
TREES	CUP ana	Cupaniopsis anacardioides	Tuckeroo	8 x 5	25 ltr	5
	TRI lau	Tristaniopsis laurina	Water Gum	8 x 5	25 ltr	5
	XAN chr	Xanthostemon cryanthus	Golden Pendas	8 x 5	25 ltr	5
SHRUBS	ACA fim	Acacia fimbriata	Fringed Wattle	3 x 3	200mm	8
	BAN eri	Banksia ericifolia	Heath Leafed Banksia	2 x 2	200mm	8
	CAL sal	Calistemon salignus	Willow Bottlebrush	3 x 2	200mm	0
	LEP pet	Leptospermum petersonii	Lemon Scented T-Tree	1.5 x 1.5	200mm	16
	MEL cla	Melaleuca cv	Claret Tops	1.5 x 1.5	200mm	16
	SYZ aus	Syzygium australe	Bush Xmas	4 x 3	200mm	16
	SYZ pan	Syzygium paniculatum	Magenta Cherry	4 x 3	200mm	16
OTHER	LOM hys	Lomandra hystrix	River Mat Rush	.75 x .75	140mm	50

PROPOSED PLANT SCHEDULE (BIO ONLY)

	CODE	SPECIES	COMMON NAME	HEIGHT & SPREAD	POT SIZE	NO.
OTHER	JUN usi	Juncus usitatis	Common Rush	1 x 1	tube	189
	LOM hys	Lomandra hystrix	River Mat Rush	.75 x .75	tube	428

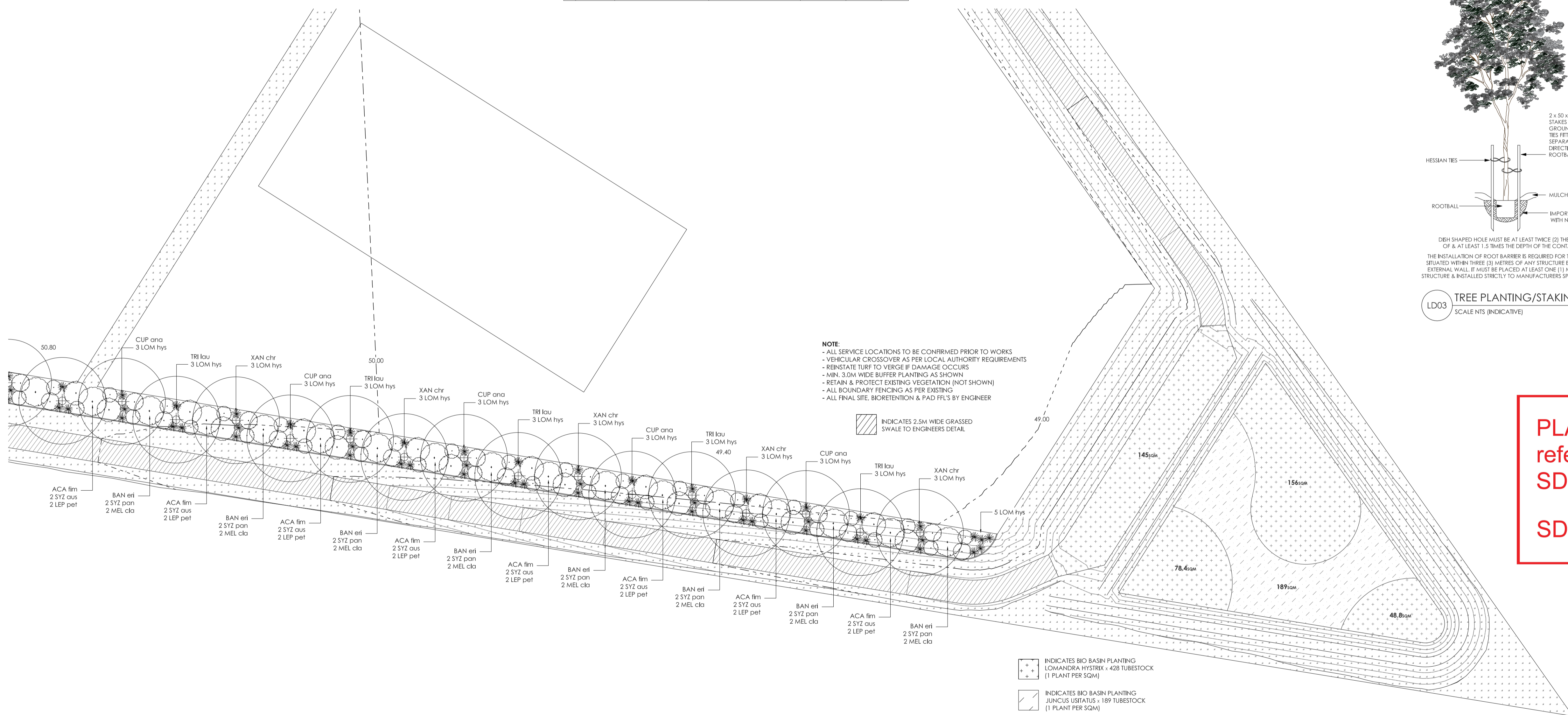
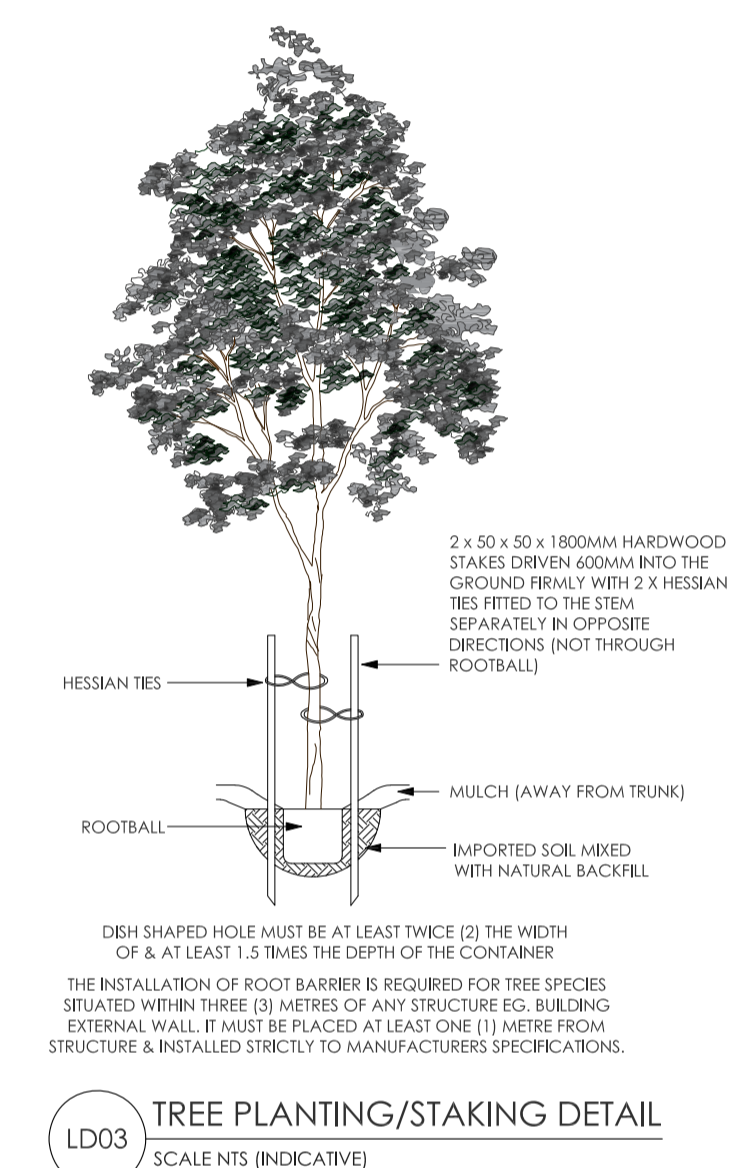
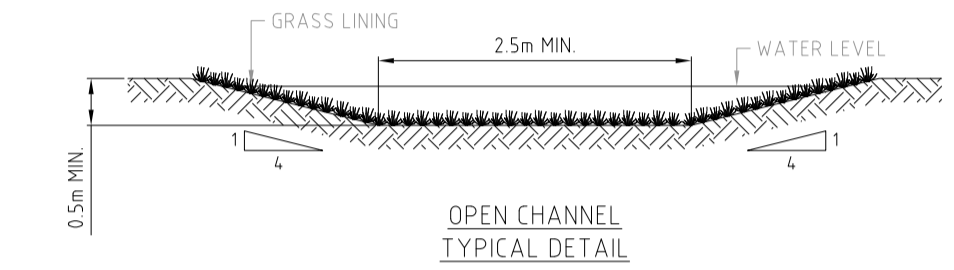
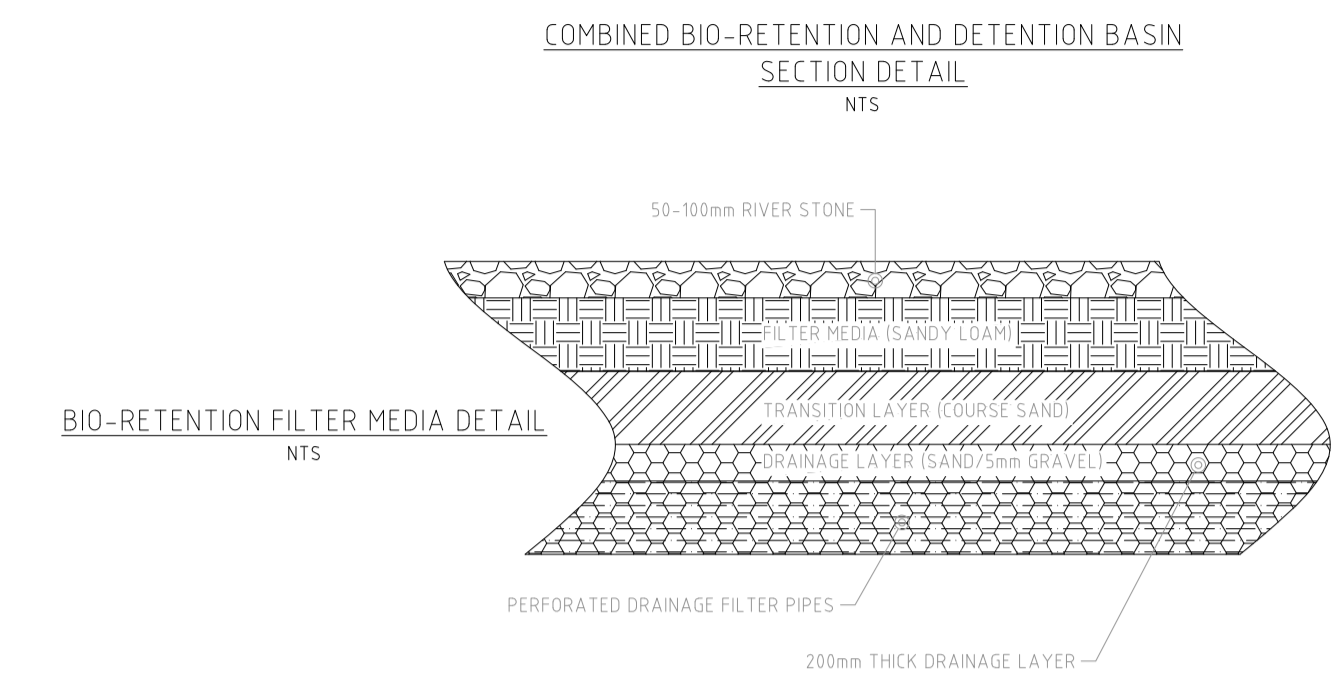

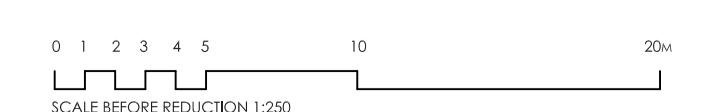
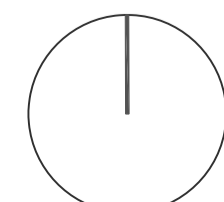

PLANS AND DOCUMENTS referred to in the SDA APPROVAL

SDA approval: AP2024/001

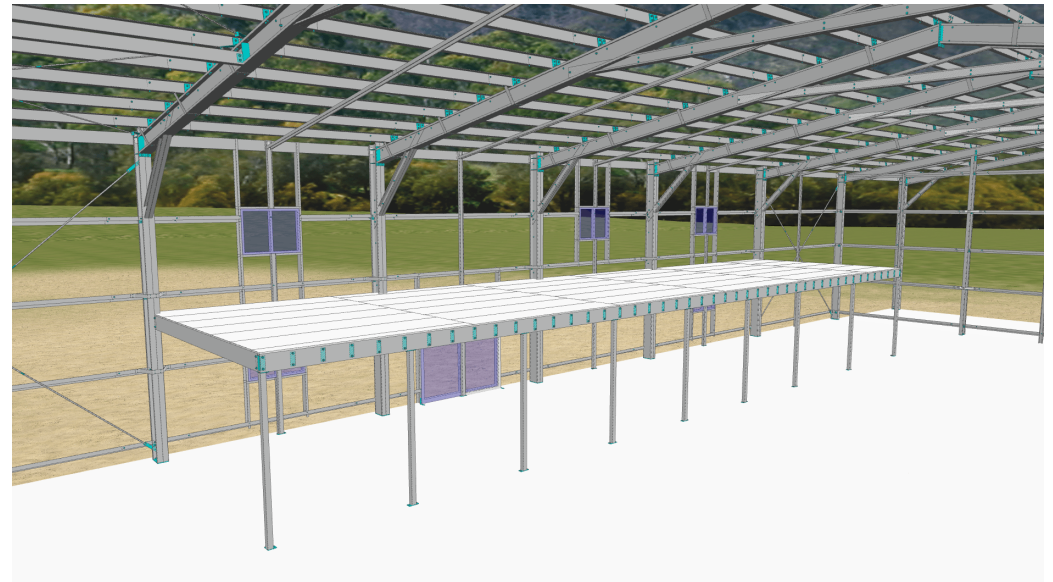
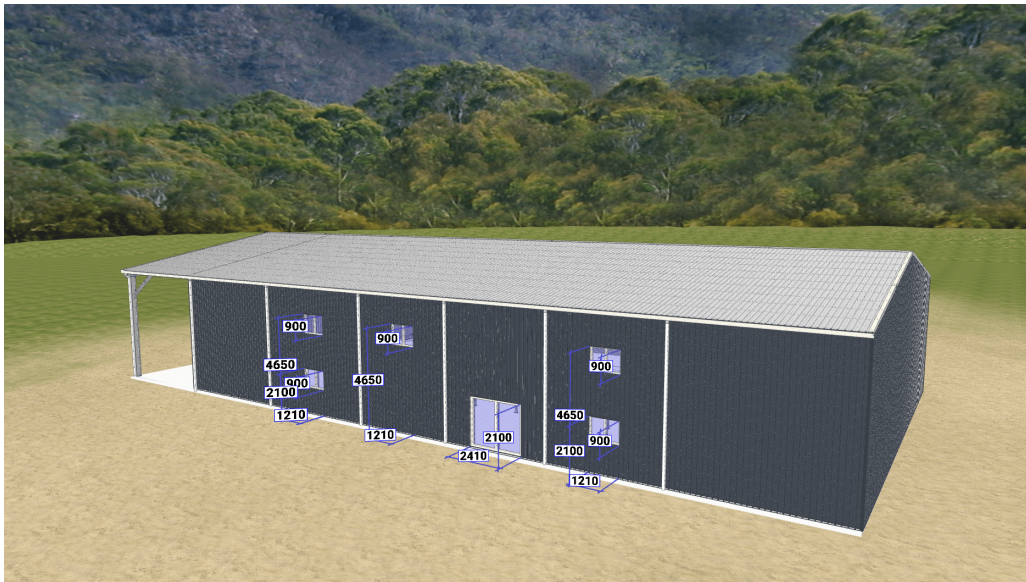



 <p>R&F Steel Buildings Brisbane West QBCC Lic. 15249426 119 Jutland Street, Oxley QLD 4075 T 0432 589 753 E brisbane.west@rfsteelbuildings.com.au</p>	PROJECT NO: P12232Q5	CUSTOMER: Boonah Cranes	SITE: 48 Kooroomba Dr Mount Alford, QLD 4310	DATE: 10/09/2023
	PROJECT NAME: Boonah Cranes		LOT: RP/SP:	ULT WIND SPEED: 49.28 m/s SERVICEABILITY: 33.72 m/s
	JOB NAME: Boonah Cranes		DRAWING No: -Boonah Cranes:	<p>PLANS AND DOCUMENTS referred to in the SDA APPROVAL</p> <p>SDA approval: AP2024/001</p> 

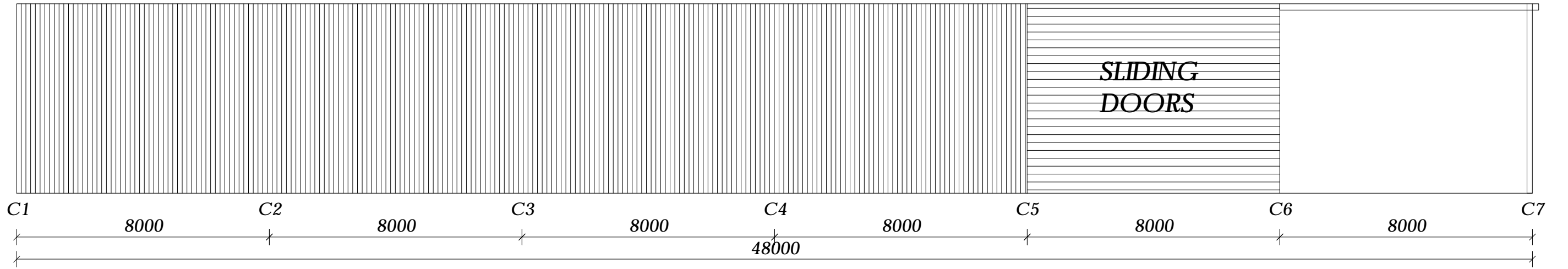

BACK SIDE

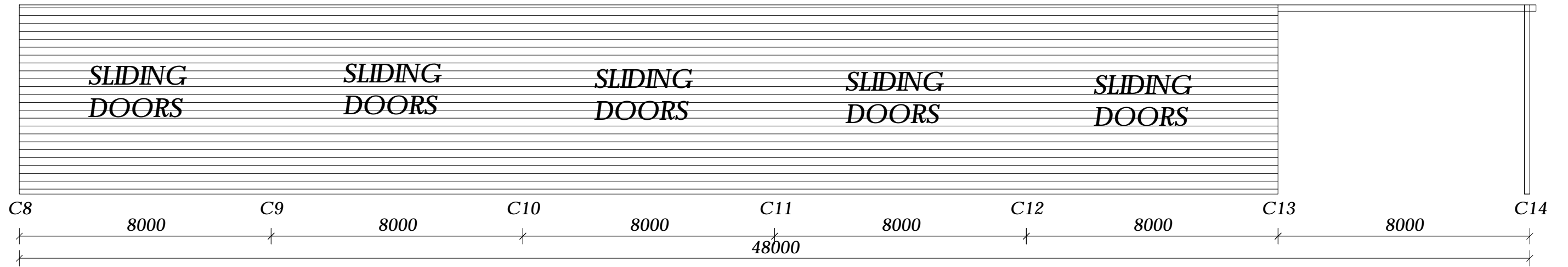

FRONT SIDE

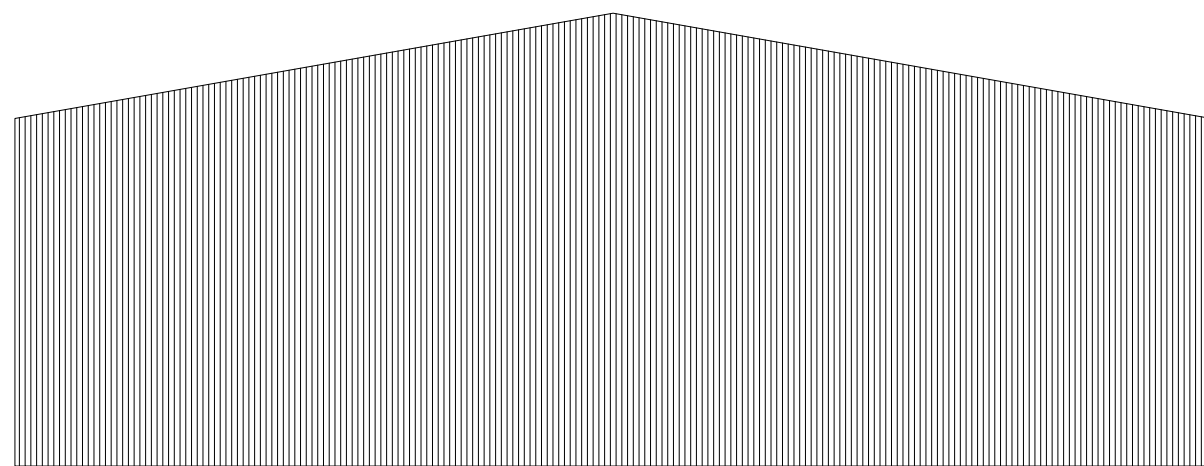

20100
END VIEW

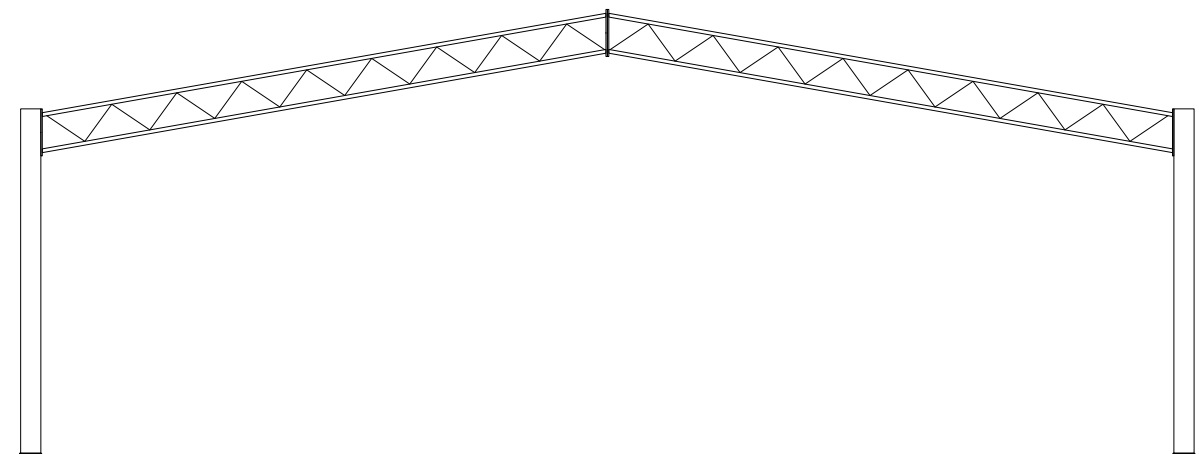

20100
END VIEW

Building Plans 01

CLIENT: VERENA JOYCE
149 SANDY CREEK ROAD
BROMELTON QLD 4285

PLANS AND DOCUMENTS
referred to in the
SDA APPROVAL
SDA approval: AP2024/001



DRAWN BY: WILL SCOTT

SCALE	SEE DRAWING
PROJECT	BOONAH CRANES
DATE	23/04/24

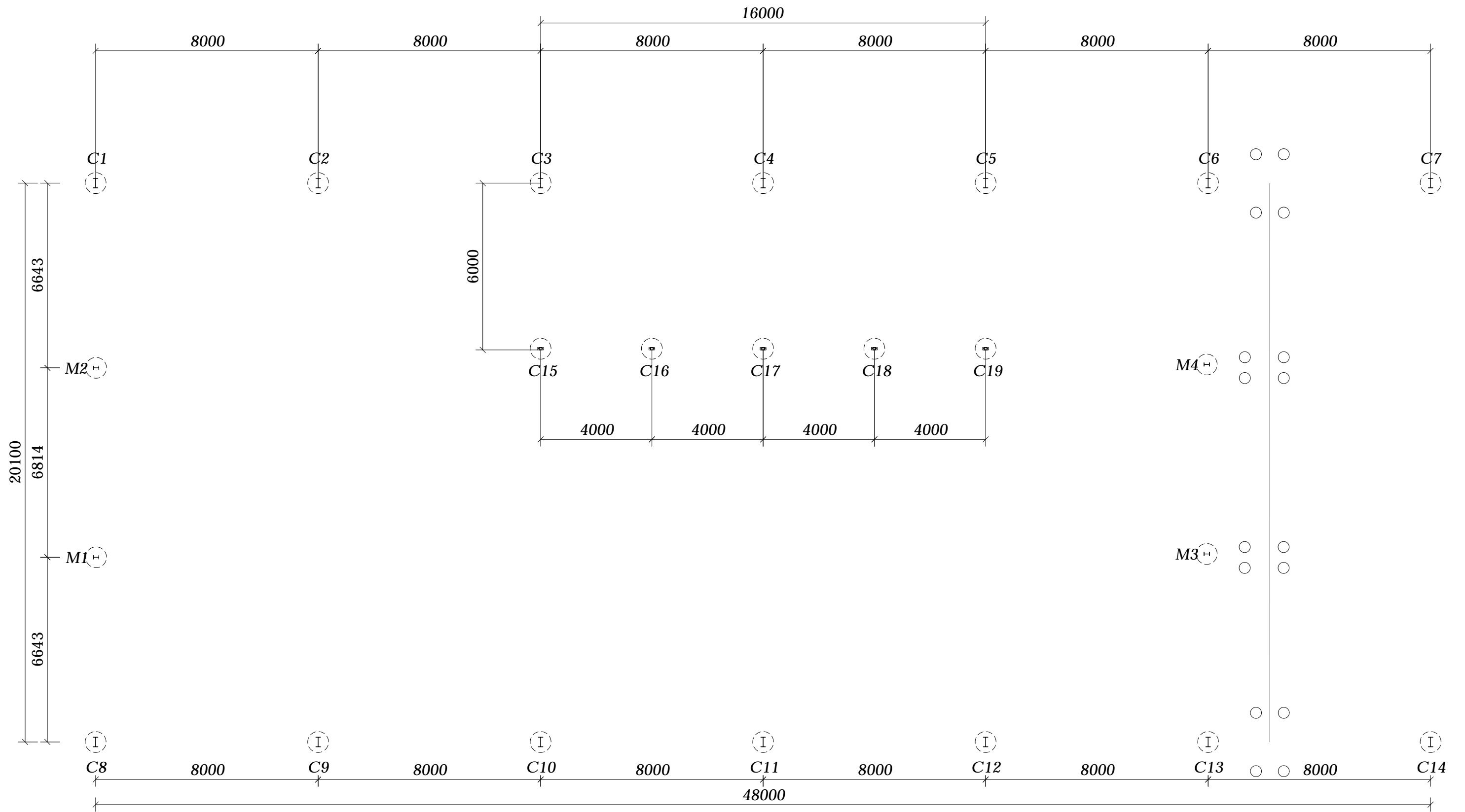

MEZZANINE FLOOR PLAN

PLANS AND DOCUMENTS
referred to in the
SDA APPROVAL



Queensland
Government

SDA approval: AP2024/001

Building Plans 02

CLIENT:	VERENA JOYCE
PAGE	149 SANDY CREEK ROAD
6/6	BROMELTON QLD 4285

DRAWN BY: WILL SCOTT

SCALE	SEE DRAWING
PROJECT	BOONAH CRANES
DATE	23/04/24

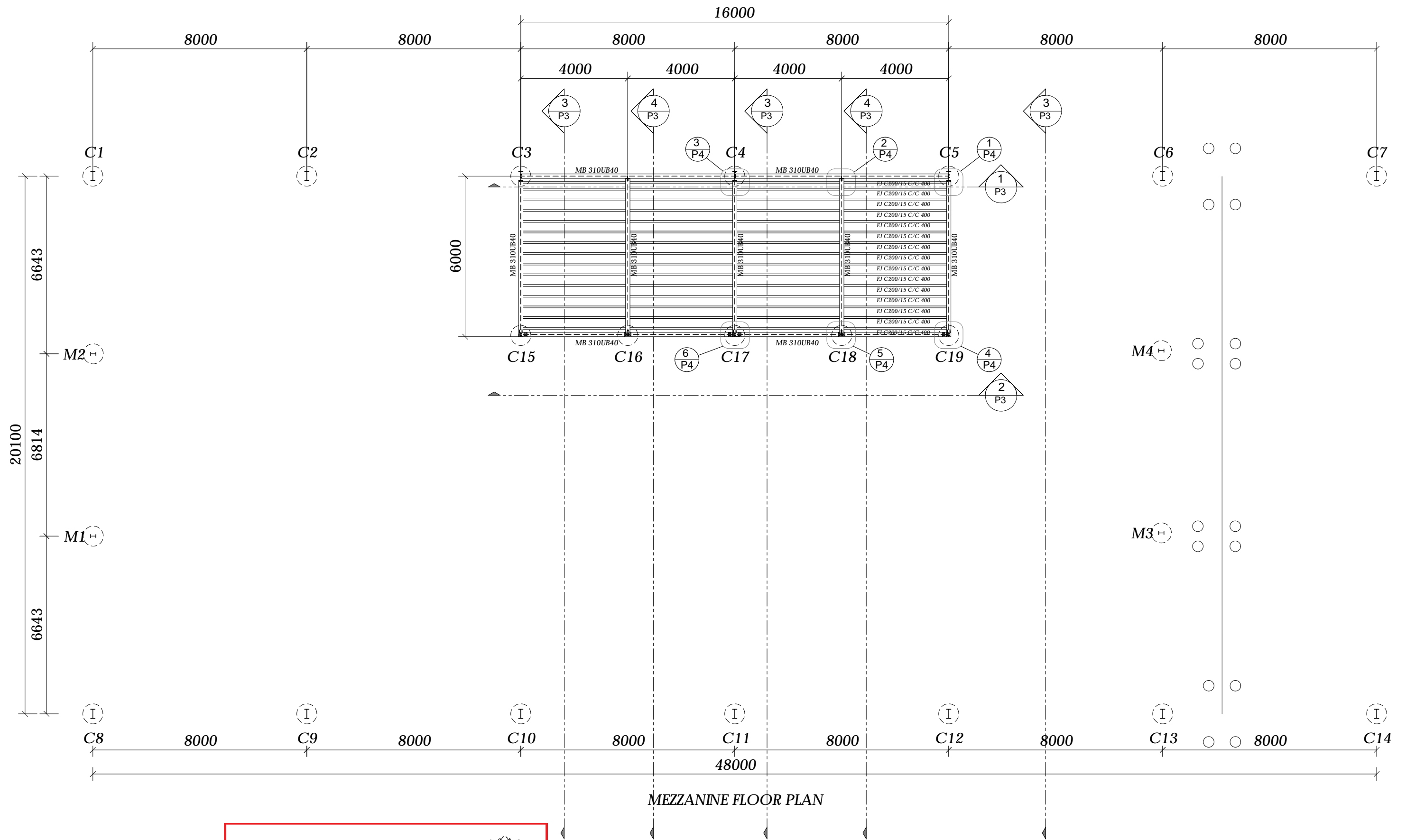

PLANS AND DOCUMENTS
referred to in the
SDA APPROVAL



SDA approval: AP2024/001

Building Plans 03

CLIENT: VERENA JOYCE
149 SANDY CREEK ROAD
BROMELTON QLD 4285

PAGE 6/6

DRAWN BY: WILL SCOTT

SCALE	SEE DRAWING
PROJECT	BOONAH CRANES
DATE	21/05/24

PLANS AND DOCUMENTS
referred to in the
SDA APPROVAL



Queensland
Government

SDA approval: AP2024/001

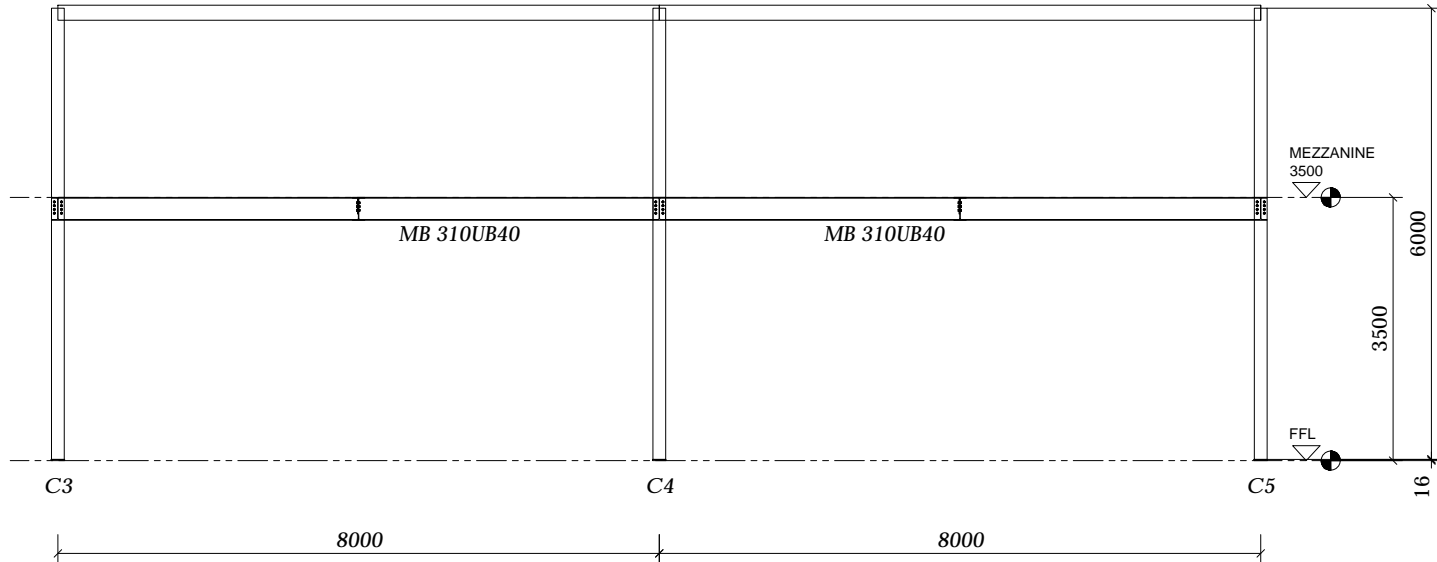

SECTION 1-1

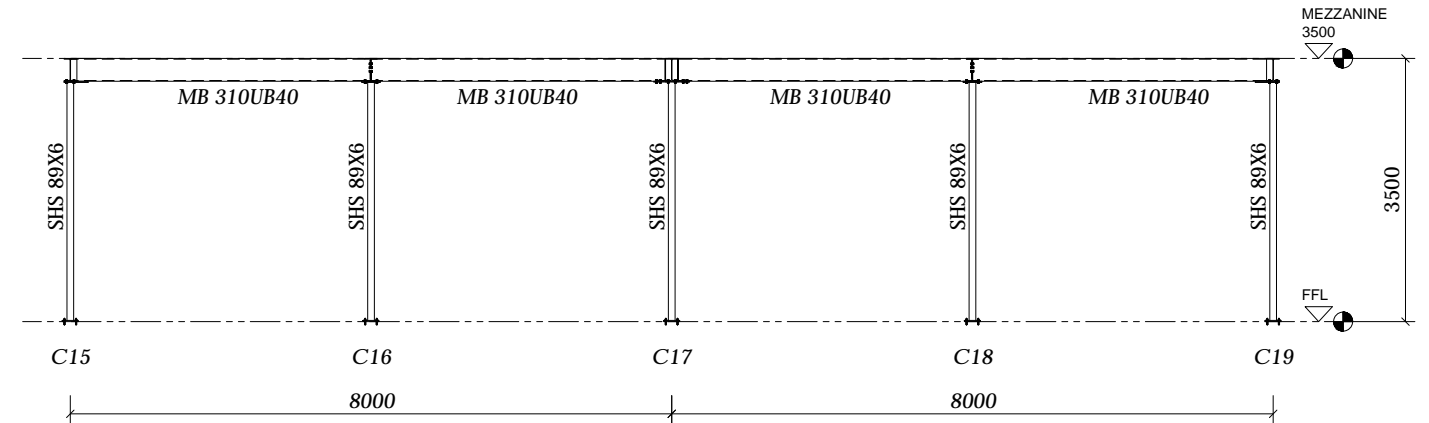

SECTION 2-2

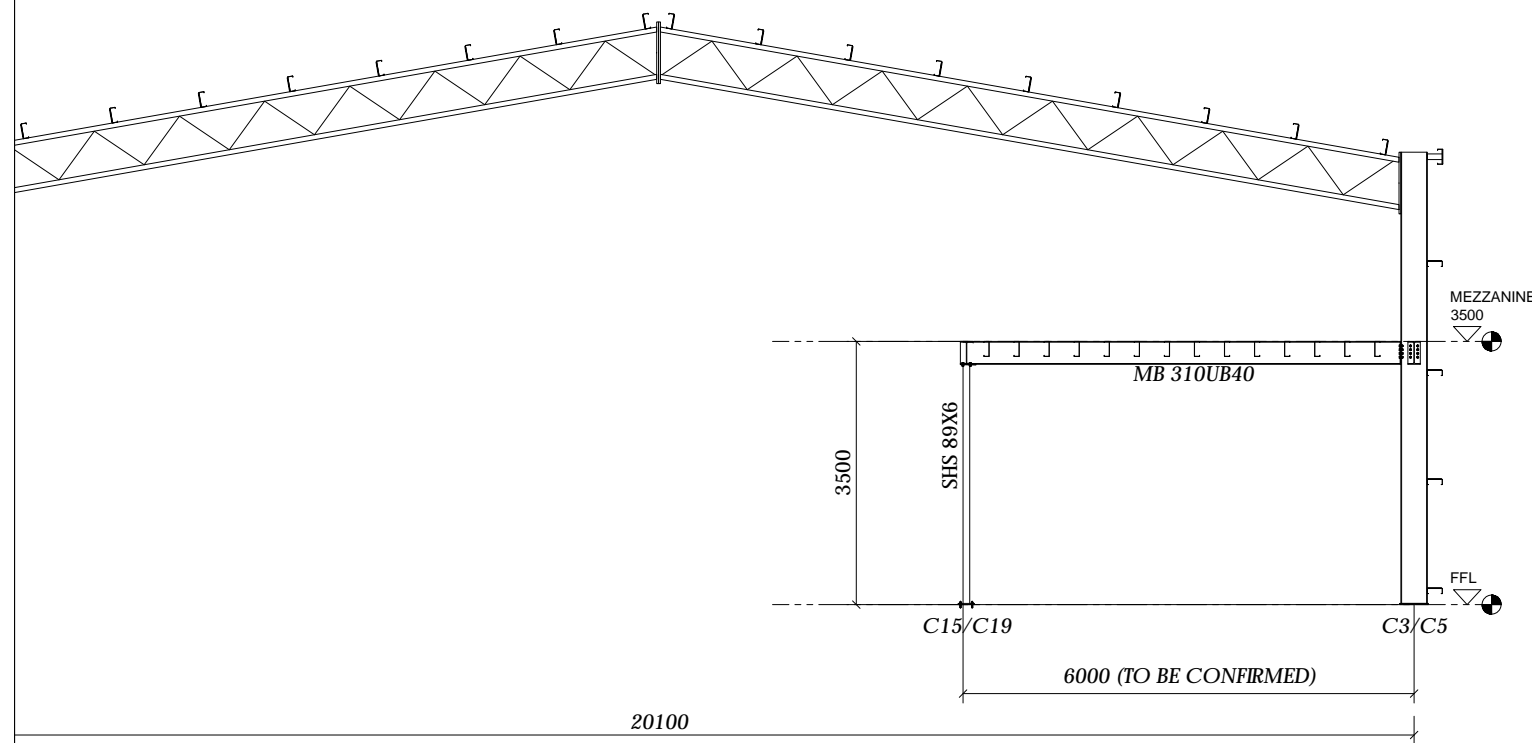

SECTION 3-3

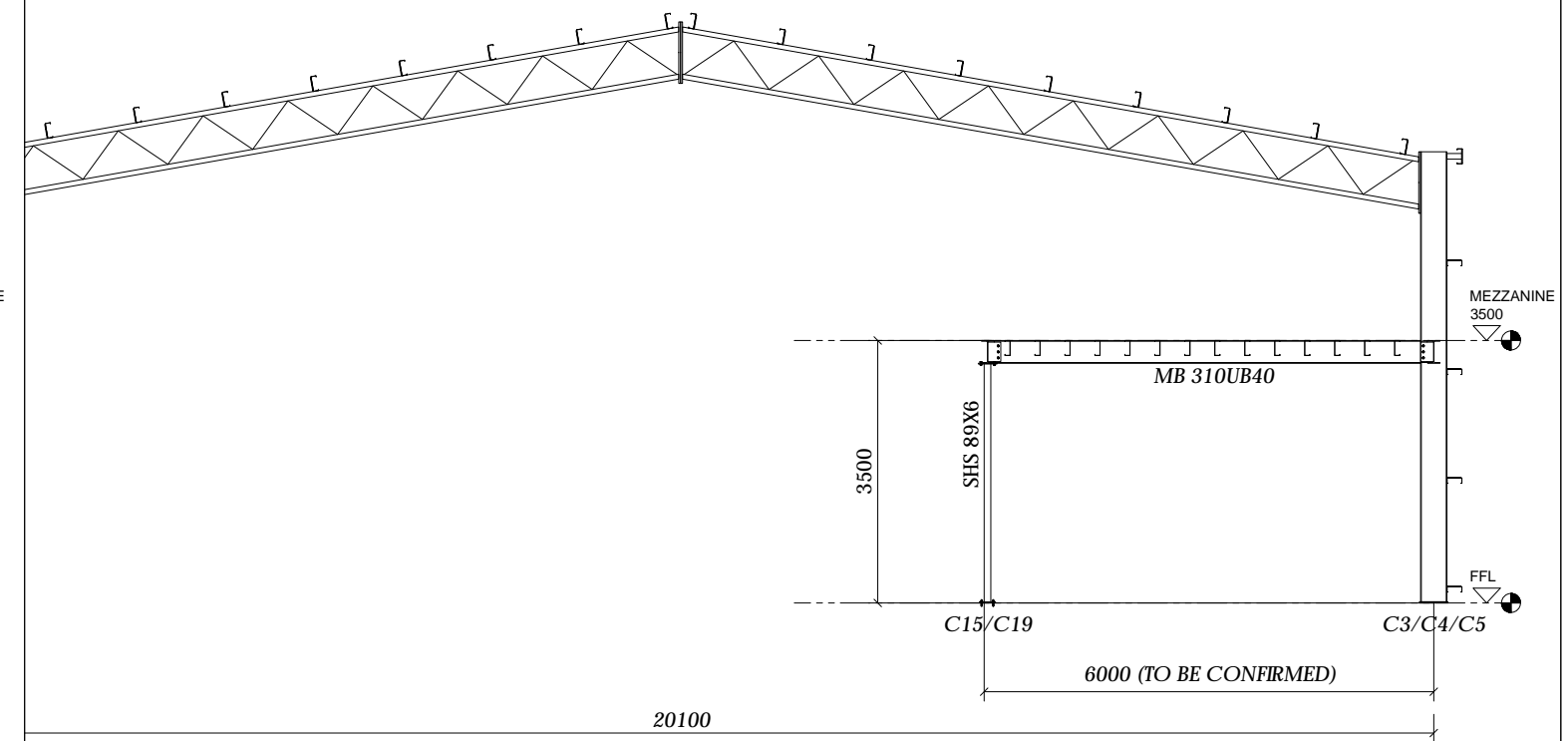

SECTION 4-4

Building Plans 05

CLIENT:	VERENA JOYCE
PAGE	149 SANDY CREEK ROAD
6/6	BROMELTON QLD 4285

DRAWN BY: WILL SCOTT

SCALE	SEE DRAWING
PROJECT	BOONAH CRANES
DATE	21/05/24

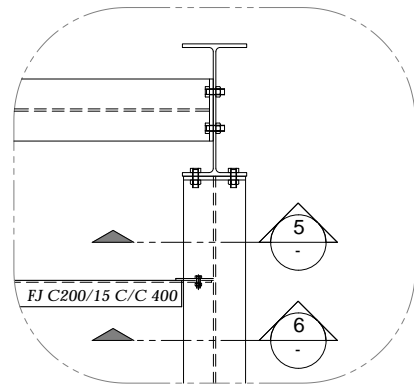

DETAIL-1

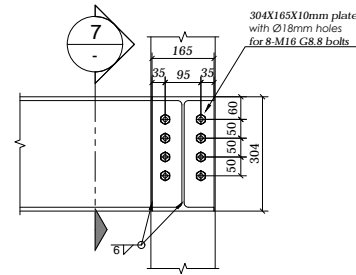

SECTION 5-5

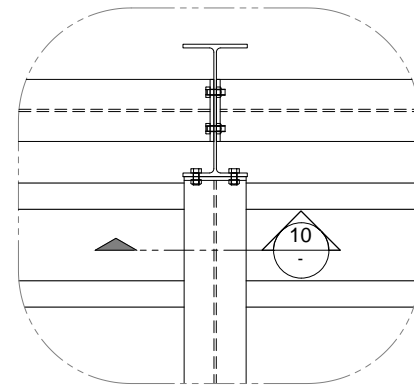

DETAIL-3

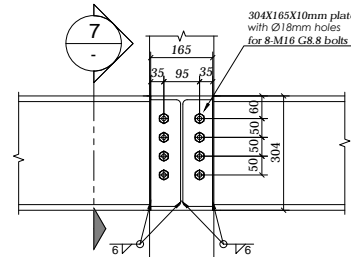

SECTION 10-10

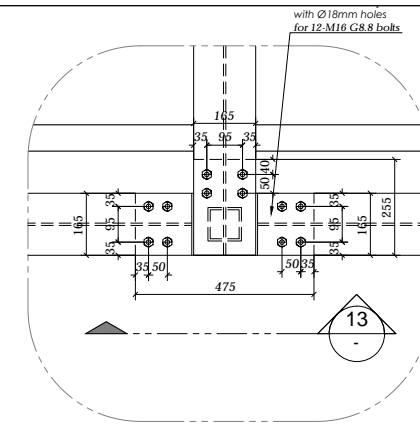

DETAIL-6

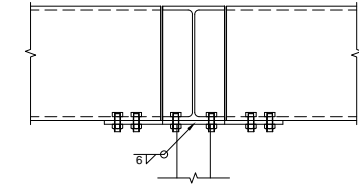

SECTION 13-13

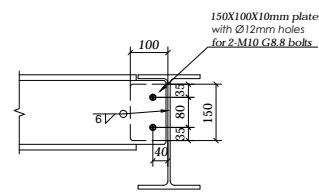

SECTION 6-6
TYP. FOR ALL FJ

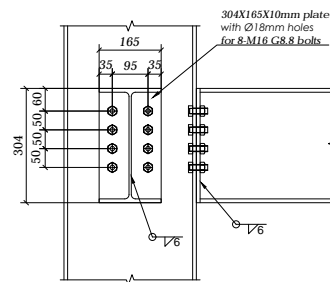

SECTION 7-7

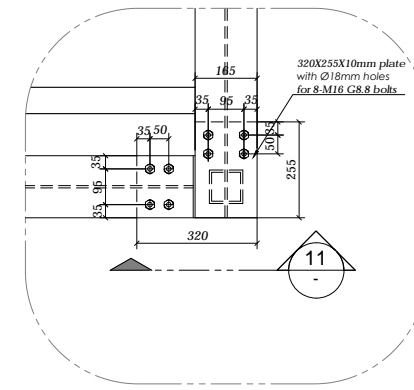

DETAIL-4

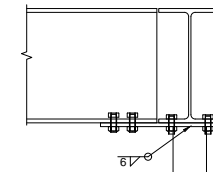

SECTION 11-11

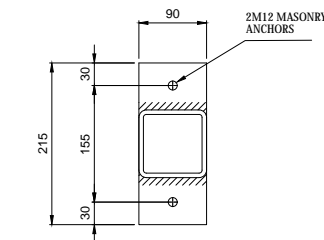

TYPICAL BASE PLATE (16mm)
DETAILS

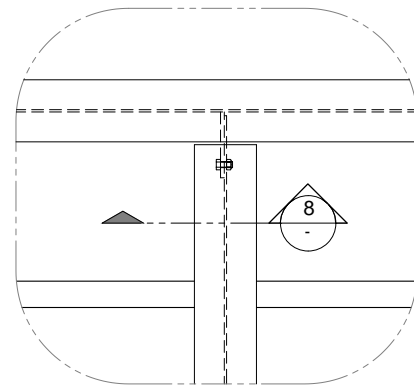

DETAIL-2

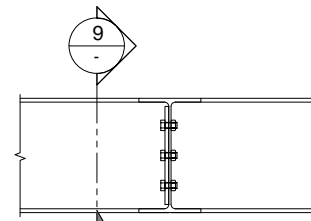

SECTION 8-8

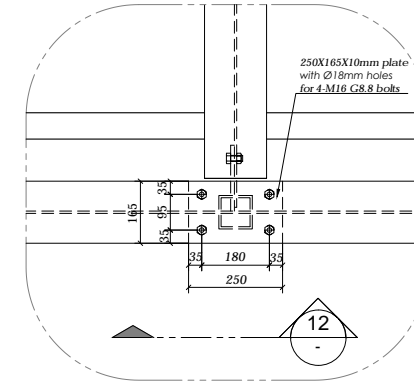

DETAIL-5

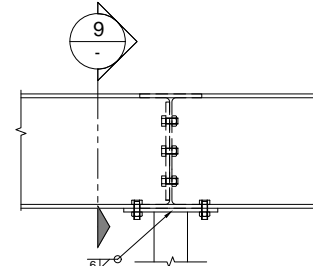

SECTION 12-12

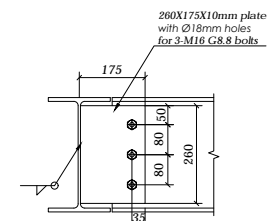

SECTION 9-9

PLANS AND DOCUMENTS referred to in the SDA APPROVAL

SDA approval: AP2024/001



ACS Engineers

CIVIL | ENVIRONMENTAL | PROJECT MANAGEMENT

Stormwater Management Plan

**Beaudesert & Boonah Cranes –
Proposed Transport Depot**

**Prepared for: Beaudesert & Boonah
Cranes**

149 Sandy Creek Road, Bromelton QLD
4285

Lot 3 RP40309

PLANS AND DOCUMENTS
referred to in the
SDA APPROVAL



SDA approval: AP2024/001

ACS Engineers

29 October 2024

230068

Document Control:-

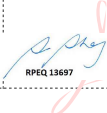
Rev No.	Author	Reviewed	Approved		Description	Date
	Name	Name	Name	Signature		
1	Matthew Westphal	Susan Shay RPEQ 13697	Susan Shay RPEQ 13697		Draft	
2	Matthew Westphal	Susan Shay RPEQ 13697	Susan Shay RPEQ 13697		Final	09/11/2023
3	Holly Mclaurin	Susan Shay RPEQ 13697	Susan Shay RPEQ 13697		Final	29/10/2024

Digitally signed
by Susan Shay:
RPEQ 13697
Date: 2024.10.29
13:12:26 +10'00'

Notes:

- Revision 1 Draft for client comment
- Revision 2 Final for use
- Revision 3 Effluent Disposal Report updated

Disclaimer:

1. ACS Engineers (Aust) Pty Ltd has taken all reasonable steps to ensure that the information contained in this publication is accurate at the time of production. In some cases, ACS Engineers (Aust) Pty Ltd has relied on information supplied by the client(s).
2. This publication has been prepared in accordance with good professional practice. No other warranty, expressed or implied, is made as to the professional advice given in this publication.
3. ACS Engineers (Aust) Pty Ltd maintains **NO** responsibility for the misrepresentation of results due to incorrect use of information contained within this publication
4. This publication should remain together and be read as a whole.
5. This publication has been prepared solely for the benefit of the client listed above. No liability is accepted by ACS Engineers (Aust) Pty Ltd with respect to the use of publication by third parties without prior written approval.

Contents

1. Introduction	1
2. Site Details / Description of Development	1
3. Stormwater Quantity	2
3.1. Catchment Description	3
3.2. Runoff Modelling	3
3.2.1. Methodology	4
3.2.2. Inputs	4
3.2.3. Analysis Results	4
4. Stormwater Management	4
5. Stormwater Quality	5
5.1. Potential Impacts	5
5.2. Proposed Stormwater Quality Management	5
5.3. Compliance	6
6. Erosion and Sediment Control	7
6.1. Construction Phase	9
6.2. Operation Phase	9
6.3. Maintenance of Controls	10
7. Conclusion	14
Appendix A) Drawing List	15
Appendix B) Seqwater Development Guidelines Assessment Benchmarks for Assessable Development – Performance Outcomes	16
Appendix C) Effluent Disposal Report	33
Appendix D) LURT Output	34
Appendix E) Rational Method Calculations	35
Appendix F) Outflow Hydrographs	37
Appendix G) MUSIC Modelling Report	38

1. Introduction

This site-based stormwater management plan has been developed to identify the potential stormwater related impacts from the proposed development on Lot 3 RP40309 at 149 Sandy Creek Road, Bromelton QLD 4285.

The following report details the stormwater management requirements for the development in order to achieve compliance with the *Bromelton State Development Area Development Scheme*, *Scenic Rim Regional Council Planning Scheme*, *Seqwater Development Guidelines for Water Quality Management in Drinking Water Catchments*, *QUDM* and the *Environmental Protection (Water and Wetland Biodiversity) Policy 2019*, specifically the necessary mitigation measures to ensure that there is:

- no worsening of the stormwater discharges from the site into downstream properties,
- no worsening of flood plain extents, and
- no increased risk of contamination of downstream surface waters.

2. Site Details / Description of Development

The subject land comprises of one allotment, Lot 3 RP40309 (4.017 ha), as shown in Figure 1. The site is located approximately 5.2km west of the township of Beaudesert and lies within the Scenic Rim Regional Council (SRRC) Local Government Area as well as the Bromelton State Development Area (BSDA). The subject lot is zoned within the Transition Precinct of the BSDA, as shown below in Figure 2.



Figure 1: Subject Site (QLD Globe, 2023).



Figure 2: BSDA Precinct of Subject Site (BSDA Planning Scheme, 2023).

The site has access via Sandy Creek Road, a local council-controlled road, constructed to a bitumen standard, and is not burdened by any easements.

As seen in Figure 2 above, the subject site is surrounded by rural properties zoned within both the Transition Precinct and the Medium-High Impact Precinct within the BSDA. The subject lot is partially developed with an existing dwelling and stables.

The proposed development includes:

- Retention of existing Dwelling House as office/caretakers residence,
- Multiple sheds ancillary to proposed transport depot use
- Hardstand areas,
- Property Access, and
- Internal driveway and parking areas.

The overall layout of the proposed development is detailed in the drawing set ACS-230068-GEN.

3. Stormwater Quantity

The proposed development including an office/caretakers residence, sheds, transport depot, hardstand areas and internal road will contribute to an increase in the overall impervious area of the site. The extent of this increase and the proposed mitigation measures to ensure no worsening of the stormwater discharges from the site into downstream properties, and no worsening of flood plain extents is detailed in the subsequent sections of this report.

3.1. Catchment Description

For the purpose of the site-based stormwater management plan, the defined catchment is limited to the external boundaries of the development site. The development site is relatively flat but can be generally described as falling to the east, towards Corcoran Road and Swan Creek, stream order 2 to 3, as seen in Figure 3.



Figure 3: Site Topography (QLD Globe, 2023).

The catchment has good grass cover and is moderately vegetated. A low soil permeability has been assumed for the stormwater runoff calculations due to the soil on site being predominantly hard pedal, red duplex soils.

3.2. Runoff Modelling

Runoff estimates have been calculated using the rational method and the project model which includes the property surface sourced from LiDAR data. The following results are to be read in conjunction with the project drawing set ACS-230068-GEN.

3.2.1. Methodology

The rational method has been used to determine the peak runoff volumes generated from the site both pre and post development. The rainfall data for the site has been sourced from the Bureau of Meteorology design rainfall data system (2016). Slopes, stream lengths, sheet flow lengths and other characteristics have all been derived from the project model, created in Civil 3D.

3.2.2. Inputs

The following catchment data is required to calculate the expected peak flows:

- Catchment area and stream lengths,
- Catchment fraction of impervious area,
- Time of Concentration (TOC), and
- IFD Data

Table 1 below details the catchment information in the pre- and post-development peak flow calculations. Time of concentration values were calculated in accordance with Friend's equation.

Table 1: Catchment Characteristics

Scenario	Catchment Area	Fraction Impervious	Time of Concentration
Pre Development	4.017 ha	0%	31 minutes
Post Development	4.017 ha	33%	20 minutes

3.2.3. Analysis Results

Table 2 below details the pre- and post-developed peak discharge rates and volumes from the site using the Rational Method. Rational method calculations and results for other AEP's are provided in Appendix E).

Table 2: Peak Discharge Rates

Scenario	Peak Discharge 1% AEP
Pre Development	1.16 m ³ /s
Post Development	1.49 m ³ /s

The increase in impervious area and shortening of the time of concentration due to the formalisation of the site drainage is expected to result in a minor increase in peak flows generated from the site. Appropriate mitigation measures must be proposed to ensure discharges rates are limited to the pre development levels and to ensure compliance with QUDM and the relevant development and planning schemes.

4. Stormwater Management

The following stormwater controls are proposed to appropriately manage stormwater through the site and maintain pre developed regimes.

- Overland flow directed perimeter bio-swale drains;
- Roof water directed to rainwater tanks with overflows directed to perimeter swale drains;
- Perimeter swale drains directed to detention basin (including bioretention cell).

The stormwater detention is proposed to be constructed within the southeast corner of the lot to ensure pre developed peak discharges are maintained. Using the Hydraulic Toolbox calculator developed by the US Federal Highways Administration and basin sizing guidance in QUDM it has been determined that the detention basin (encompassing permanent storage) must have a base area of 600m² and depth to lowest outlet of 0.65m to account for the reduction in initial loss and resulting changes to the runoff hydrograph. The detention outlet structure (weir and low flow pipes) has been sized to convey pre developed flow rates and return flows to pre developed regimes. Refer to Appendix F) for flow hydrograph details. It should be noted that the detention basin sizing has been based on the assumption that shed rainwater tanks (potable uses) are all full at the commencement of the rainfall event.

Stormwater on site and discharging from the site will be managed in accordance with this report and project drawing ACS-230068-GEN.

It is expected that the existing lawful point of discharge will be maintained should these controls be implemented as part of the development works.

5. Stormwater Quality

5.1. Potential Impacts

On site operations have the potential to impact on surface runoff water quality if inadequately managed. These activities may include:

- Initial construction phase development (e.g. groundcover/topsoil stripping, road and hardstand construction);
- Increased oils, greases, fuels and other chemicals due to increased traffic activity;
- Spillage during handling and transport of materials; and
- Effluent disposal.

Urbanisation has the potential to increase the quantity of stormwater pollutants that are discharged to receiving waters. This can have a detrimental effect on those receiving environments and potentially impact the natural water cycle, ecological health and drinking water supplies.

5.2. Proposed Stormwater Quality Management

The potential impacts of on site operations for the subject site prompt the requirement of a stormwater quality treatment train. The treatment train consists of the following:

1. Stormwater runoff from roof to be directed into rainwater tanks;
2. Tank overflows and hardstand areas directed to vegetated swale drains;
3. Swale drains to be directed to detention basin with bioretention cell; and
4. Captured water in rainwater tanks and detention basin to be reused on site for potable and irrigation uses.

The stormwater quality treatment train is shown on drawing ACS-230068-GEN-08 and in Figure 4 below.

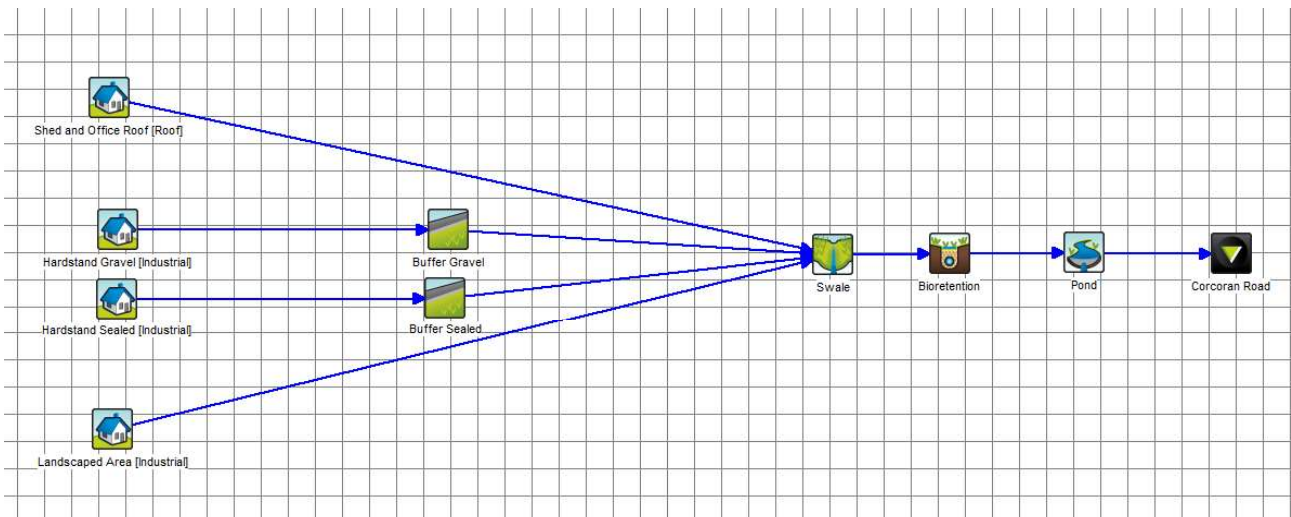

Figure 4 - MUSIC Treatment Train

Effluent disposal from the existing building and proposed new sheds will be undertaken in accordance with the Site and Soil Evaluation Report (Stavs Hydraulic Services, 13th October 2023). Refer to Appendix C).

5.3. Compliance

The established controls have been assessed to ensure the achievement of reductions in mean annual nutrient loads from an unmitigated development.

The existing and developed drainage path characteristics, along with source contaminant characteristics, were modelled using the MUSIC software in accordance with MUSIC Modelling Guidelines (Water By Design, 2018). The reduction targets are outlined in Table 3 below along with the modelled train effectiveness, demonstrating compliance with the reduction targets. The MUSIC Modelling Report can be provided upon request for model input and results information.

Table 3: Nutrient Removal Targets and Model Results

Nutrient Parameter	Reductions in mean annual load from unmitigated development (Seqwater Guidelines)	Modelled Treatment Train Effectiveness
Total Suspended Solids (kg/yr)	85% Reduction	90.6%
Total Phosphorous (kg/yr)	65% Reduction	76.2%
Total Nitrogen (kg/yr)	45% Reduction	45.1%
Gross Pollutants (kg/yr)	95% Reduction	100%

If best practice management is followed, along with the proposed stormwater quality management controls, the quality of the stormwater discharging from the site is expected to remain at or below pre-development quality. Runoff from all disturbed areas of the site will be directed to the detention basin for sediment capture and nutrient removal.

The proposed development will also achieve the requirements of the *Seqwater Development Guidelines for Water Quality Management in Drinking Water Catchments*. Refer to Appendix B), Appendix C), Appendix D) and Appendix G).

6. Erosion and Sediment Control

Sediment will be generated as a result of the proposed development works. While the potential exists for sediment to be generated during the construction phase, the potential sediment volume is dependent upon rainfall, site topography, the material type exposed, flow characteristics, and the construction practices and program.

The potential sediment yield during construction will vary with the extent of site exposed during the construction programme. It is recommended that the following measures be adopted along with the whole of site and construction stage specific erosion and sediment control plans detailed on drawings ACS-230068-GEN-10 to 14 to ensure that the water quality of the receiving waters is not adversely impacted by the proposed development works.

Potential erosion and sediment generation and risk assessment is undertaken using the Revised Universal Soil Loss Equation (RUSLE).

RUSLE calculates annual erosion rates based on:

$$A = R \times K \times LS \times C \times P$$

Where:

- A = annual soil loss due to erosion (t/ha/yr)
- R = rainfall erosivity factor
- K = soil erodibility factor
- LS = topographic factor derived from slope length and gradient
- C = cover and management factor
- P = erosion control practice factor

Table 4 below shows the factors used for the erosion risk assessment.

Table 4: RUSLE Factors Used for Assessment

Factor	Reference	Value
R	Calculated from Table E1 from the IECA Best Practice Erosion and Sediment Control, Book 2, Appendix E.	2231.901
K	Table E4 from the IECA Best Practice Erosion and Sediment Control, Book 2, Appendix E.	0.025
LS	Table E3 from the IECA Best Practice Erosion and Sediment Control, Book 2, Appendix E.	0.58
C	Table E9 from the IECA Best Practice Erosion and Sediment Control, Book 2, Appendix E.	1
P	Table E11 from the IECA Best Practice Erosion and Sediment Control, Book 2, Appendix E.	1.3

Figure 5 and Figure 6 below show the calculated annual soil loss and associated risk assessment, varied by the LS factor.

Slope Ratio	Slope Gradient (%)	Slope Length (m)							
		10	20	30	40	50	60	70	80
1 in 100	1	7	8	9	11	12	12	13	14
1 in 50	2	10	13	17	20	22	25	26	28
1 in 33	3	12	17	25	30	34	38	41	44
1 in 25	4	15	22	32	39	46	52	57	62
1 in 20	5	17	26	39	49	58	66	73	80
1 in 16.6	6	20	30	46	59	70	81	90	99
1 in 12.5	8	25	38	58	78	95	110	123	122
1 in 10	10	30	49	79	104	127	148	168	186
1 in 8.3	12	38	62	101	134	165	193	219	244
1 in 7.1	14	45	74	123	164	202	238	271	303
1 in 6.3	16	52	86	144	194	240	283	324	363
1 in 5.5	18	58	98	165	223	277	327	375	421
1 in 5	20	65	109	185	252	313	371	427	479
1 in 4	25	79	136	234	321	402	478	551	622
1 in 3.3	30	93	162	280	386	485	580	670	
1 in 2.5	40	117	205	361	502	634			
1 in 2	50	136	242	427	596				

Figure 5 - Annual Soil Loss and Erosion Risk Ratings for Various Slopes

Soil Loss Class	Soil Loss Rate (t/ha/yr)	Soil Erosion Risk Rating
1	0 to 150	Very Low
2	151 to 225	Low
3	226 to 350	Low-moderate
4	351 to 500	Moderate
5 to 6	501 to 1500	High
7	above 1500	Extremely High

Figure 6: Erosion Risk Rating Definitions

Table 5: Annual Soil Loss Estimate and Control Type Recommended

Result	Rate	Value
A	t/ha/yr	42
A	t/yr	169
Control		Type 3

The subject site has a very low soil erosion risk rating. However, erosion and sediment controls are required to mitigate against any potential risks.

Erosion and sediment control measures are to be adopted in accordance with IECA Best Practice Erosion and Sediment Control, and drawings ACS-230068-GEN-10 to 14, and the measures are outlined below.

6.1. Construction Phase

- a) Construct stabilised shake down area at the site access;
- b) Construct diversion drains and direct to existing detention basin as detailed on the engineering plans;
- c) Erect sediment controls including mulch bunds as detailed on the engineering plans;
- d) Strip topsoil and stockpile within the controlled area on site;
- e) Carry out bulk earthworks involving cut to fill;
- f) Exposed soils and stockpiles are to be watered, as required, to minimise soil losses as a result of wind;
- g) Finalised earthworks to be top soiled and seeded or landscaped as directed;
- h) Maintain all sediment devices and other interim controls regularly; and
- i) Remove sediment controls after the establishment of the landscaping and grass cover.

6.2. Operation Phase

- a) Drains to be turfed, or grass seeded with turf reinforcing matting overlain. Water collected within the detention basin may be used for watering grass seed;
- b) Basin in/outflow areas to be lined with geotextile, overlain by 50mm rock and allowed to grass over for velocity and scour control; and
- c) All embankments post construction to be turfed, grass seeded, or stabilised with plants and heavy mulching.

6.3. Maintenance of Controls

Table 6: Maintenance of Controls

Type of Maintenance Control	Measures
General	<p>These notes must be read in conjunction with the erosion and sediment control site plan and associated notes. Should there be a discrepancy in notes between documents, this document takes precedence.</p> <p>The Owner is responsible for the installation and maintenance of the erosion and sediment control measures during the construction phase.</p> <p>In the event that site conditions change considerably from those considered within this management plan, a revised erosion and sediment control plan must be designed and implemented.</p> <p>All erosion and sediment control measures, including drainage control, must be maintained in proper working order at all times during their operational lives.</p> <p>Sediment removed from sediment traps and places of sediment deposition must be disposed of in a lawful manner that does not cause ongoing soil erosion or environmental harm.</p>
Land Clearing	<p>Land clearing should not occur unless preceded by the installation of all necessary drainage and sediment control structures. The exemption would be any land clearing necessary to allow installation of these control measures.</p> <p>Land clearing is to be staged according to the relevant staging plans.</p> <p>If vegetation clearing required, it must be carried out well in advance of earthworks, this clearing should be limited to the removal of woody vegetation only.</p> <p>Clearing and grubbing and removal of existing ground cover should not occur until immediately prior to earthworks occurring in that stage of works.</p>
Construction Staging	<p>Where possible, the bulk of the earth works should occur when rainfall totals are typically at the lowest for the year.</p> <p>Construction staging to occur in accordance with the approved construction staging plans.</p> <p>All new erosion and sediment controls are to be constructed, and existing controls cleaned, prior to the construction of the next stage of the project.</p>
Site Access	<p>Site entry/exit points shall be appropriately managed to minimise the risk of sediment being tracked onto sealed, public roadways.</p>
Soil Stockpiling	<p>If any soils are to be stockpiled on site, stockpiles must be:</p> <ul style="list-style-type: none"> • Appropriately protected from wind, concentrated surface flow and excessive up-slope stormwater surface flows,

	<ul style="list-style-type: none"> • Located at least 2m away from any hazardous area, retained vegetation, or drainage area, • Located up-slope of an appropriate sediment control system (correctly installed sediment fence), and • Provided with an appropriate protective cover (synthetic, mulch or vegetative) if soil is to be stockpiled for more than 28 days.
<p>Site Monitoring</p>	<p>Erosion and sediment control measures to be inspected daily by the site manager (or nominated representative) during periods of runoff-producing rainfall, and de-silted, repaired and amended as appropriate.</p> <p>Daily site inspections, during periods of runoff-producing rainfall must include:</p> <ul style="list-style-type: none"> • All drainage, erosion and sediment control measures; • Occurrences of excessive sediment deposition (whether on site or off site); and • All site discharge points. <p>Weekly site inspections must include:</p> <ul style="list-style-type: none"> • All drainage, erosion and sediment control measures; • Occurrences of excessive sediment deposition (whether on site or off site); • Occurrences of construction materials, litter or sediment placed, deposited, washed or blown from the site, including deposition by vehicular movements; • Litter and waste receptors; and • Oil, fuel and chemical storage facilities. <p>Site inspections immediately prior to anticipated runoff-producing rainfall must include:</p> <ul style="list-style-type: none"> • All drainage, erosion and sediment control measures. <p>Site inspections immediately following runoff-producing rainfall must include:</p> <ul style="list-style-type: none"> • Treatment and de-watering requirements of sediment basins; • Sediment deposition within sediment basins and the need for its removal; • All drainage, erosion and sediment control measures; • Occurrences of excessive sediment deposition (whether on site or off site);

	<ul style="list-style-type: none"> • Occurrences of construction materials, litter or sediment placed, deposited, washed or blown from the site, including deposition by vehicular movements; and • Occurrences of excessive erosion, sedimentation, or mud generation around the site office, car park and material storage areas. <p>In addition to the above, monthly site inspections must include:</p> <ul style="list-style-type: none"> • Surface coverage of finished surfaces (both area and percentage cover); • Health of recently established vegetation; and • Proposed staging of future site clearing, earthworks and site/soil stabilisation.
<p>Drainage Management Control</p>	<p>Inspect all drainage lines for erosion around the edges of the drain prior to forecast rainfall, and after significant runoff producing storm events, and repair if required.</p> <p>Check for movement of, or damage to, the drain and immediately repair as necessary.</p> <p>During construction, all reasonable and practicable measures must be implemented to control flow velocities in such a manner that prevents soil erosion along drainage paths and at the entrance/exit point of all drains and drainage structures.</p> <p>All temporary earth banks, flow diversion systems, and sediment basin embankments must be machine compacted, seeded and mulched within 10 days of formation for the purpose of establishing a vegetative cover, unless otherwise stated in an approved Vegetation Management Plan.</p> <p>Remove all sediment from the drains prior to and after rainfall events to ensure the sediment pond capacity is maintained.</p>
<p>Sediment Management Control</p>	<p>Inspect coarse sediment traps prior to forecast rain events and after runoff producing storm events. All necessary repairs are to be made immediately. When making repairs, restore the system to the original configuration, unless an amended layout is required or specified.</p> <p>If the fabric is sagging at any point, install additional support posts/stakes.</p> <p>Remove any accumulated sediment in sediment traps or catch drains if the sediment deposit exceeds a depth of 100mm.</p> <p>All detention basins are to be inspected after each runoff event. If damage has occurred at inlet and outlet weir locations, make the necessary repairs. Clean out accumulated sediment once basin storage has been decreased by 20%.</p> <p>Water within the detention basin is to be reused on site only and can be used for dust suppression and vegetation watering.</p>

	<p>Reuse of water from the detention basin is to be undertaken in a manner which does not cause erosion in the applied area.</p>
<p>Site Rehabilitation/Revegetation Management</p>	<p>Site revegetation must occur in accordance with the approved vegetation plan.</p> <p>A minimum 70% ground cover must be achieved on all non-completed earthworks if further construction activities or soil disturbances are likely to be suspended for more than 30 days.</p> <p>No completed earthworks surface shall remain denuded for longer than 60 days.</p> <p>All cut and fill earth batters must be topsoiled and grassed/seeded within 10 days of completion of grading.</p> <p>Maintenance responsibility for the establishment of vegetation, that is the requirement to irrigate the plants and grass used to generate ground cover, lies with the Owner.</p>
<p>Responses to Complaints</p>	<p>Complaints during this type of construction usually relate to noise and dust. Generally, the complaint is made known to the Contractor, the Principal, the Superintendent and/or the Council.</p> <p>The Contractor shall keep a record of all complaints identifying the nature of the complaint and any remedial action taken to address such complaint. The Contractor shall act as soon as possible to remedy the problem, if the complaint is considered valid and reasonable. A complaints record shall be made available by the Contractor for regular inspection by the Superintendent. For the purpose of direction by others, the Contractor's details are to be supplied to Council prior to commencement of the works.</p> <p>Complaints relating to dust shall require the Contractor to immediately water the exposed earth surfaces and any soil stockpile areas as well as haul roads to control dust. Such watering shall occur immediately when the complaint is registered with the Contractor. Watering should continue periodically until conditions suit, or the works are completed to a state that prevents dust transport.</p>

7. Conclusion

The Stormwater Management Plan Report has demonstrated that the potential stormwater impacts associated with the proposed development are within acceptable and manageable limits. The proposed development is unlikely to have any adverse impacts on neighbouring properties and the surrounding environment, with respect to stormwater quantity and quality.

If best practice management is followed, along with the proposed stormwater quantity and quality management controls, the site will achieve compliance with the *BSDA Development Scheme*, the *Scenic Rim Regional Council Planning Scheme*, the *Seqwater Development Guidelines for Water Quality Management in Drinking Water Catchments* and the *Environmental Protection (Water and Wetland Biodiversity) Policy 2019* and the likelihood of environmental harm will be low.

This report is to be read and implemented in conjunction with the stormwater management and general layout plans ACS-230068-GEN.

Appendix A) Drawing List

Sheet Number	Sheet Title	Revision
01	COVER SHEET	1
02	GENERAL NOTES	1
03	TYPICAL DETAILS	1
04	OVERALL LAYOUT PLAN	1
05	TURNING TEMPLATES	1
06	PROPERTY ACCESS LAYOUT PLAN	1
07	SIGHT DISTANCE ASSESSMENT	1
08	STORMWATER LAYOUT PLAN	1
09	BIO-DETENTION BASIN DETAILS	1
10	ESC NOTES- SHEET 01	1
11	ESC NOTES- SHEET 02	1
12	ESC NOTES- SHEET 03	1
13	ESC NOTES- SHEET 04	1
14	ESC LAYOUT PLAN	1

Appendix B) Seqwater Development Guidelines Assessment Benchmarks for Assessable Development – Performance Outcomes

Performance Outcomes		Acceptable Outcomes	Compliance
Separation distances			
PO1 Development maintains an adequate separation distance and avoids areas of potential flood inundation to protect waterways or water supply sources.	AO1.1 Development complies with the separation distances and other locational criteria specified in Table 5. Note: Where another setback distance or locational criteria is identified within this code, the higher standard applies.	Complies: The proposed development is located more than 50m from the nearest waterway Swan Creek (stream order 3) and the 1% AEP flood extent. Refer to drawing set ACS-230068-GEN for details.	
Wastewater (other than domestic wastewater)			
PO2 Development does not discharge wastewater unless demonstrated to not comprise the drinking water supply environmental values. Note: Drinking water supply environmental values are referenced within Schedule 1 of the <i>Environmental Protection Policy (Water) 2009</i> .	AO2.1 Development does not generate wastewater. OR AO2.2 If development generates wastewater, the wastewater is collected and contained on-site, and is: <ul style="list-style-type: none"> a. lawfully disposed to sewer; b. transferred off-site for treatment/disposal to an appropriately licensed facility; c. reused on-site in a closed-cycle irrigation scheme, industrial processes, washing/cleaning or other purpose; or 	Complies: The proposed development does not generate wastewater other than domestic wastewater.	

Performance Outcomes	Acceptable Outcomes	Compliance
<p>PO3</p> <p>Where treated wastewater is irrigated to land, it will:</p> <ul style="list-style-type: none"> a. be confined to a dedicated area of land on-site; b. be suitably located and sized; and c. use irrigation practices that will not harm groundwater and on-site surface water quality. <p>Note: Developments involving the irrigation of wastewater will need to provide a MEDLI Modelling Report demonstrating the nominated land area for wastewater irrigation is suitably located and sized to accommodate design wastewater loads, storages are suitably sized to accommodate design wastewater loads, and proposed irrigation practices will not damage water quality. It is recommended the modelling exercise incorporate scenarios</p>	<p>d. treated to meet the drinking water supply environmental values prior to release.</p> <p>Note: Where development involves the release of wastewater, a Wastewater Management Plan (WWMP) is to be prepared by a suitably qualified person. Plans are to provide an assessment of all risks and associated mitigation strategies for preventing adverse impact on the quality of drinking water and may require a water quality monitoring program.</p> <p>No acceptable outcome is nominated.</p>	<p>Complies: The proposed development does not generate wastewater other than domestic wastewater.</p>

Performance Outcomes		Acceptable Outcomes	Compliance
based on both a 10-year and 20-year planning horizon.			
Solid waste			
PO4	Solid wastes generated by the development must be managed, stored and disposed in a manner that does not adversely impact on the quality of any surface water or groundwater.	<p>The following acceptable outcomes are applicable to intensive animal industry only. For all other development, no acceptable outcome is nominated.</p> <p>AO4.1</p> <p>The stockpiling of waste litter, manure and other organics is undertaken as follows:</p> <ol style="list-style-type: none"> on surfaces constructed with permanent impervious underlay to prevent leaching (groundsheets will only be accepted where stockpiling is temporary); located outside of an effluent irrigation area; located 3m above the seasonal high-water table and away from recharge areas; sized to accommodate the proposed disposal timeframes; designed with run-off diversion drainage upstream to prevent uncontaminated stormwater movement into the area; bunded to capture contaminated run-off for appropriate treatment and disposal; and 	<p>Complies: The proposed development site is located within SRRC's domestic waste collection zone. Any commercial waste/non-standard domestic waste is able to be transported by the residents/operators to Council's nearest waste disposal facility at Bromelton. The proposed development is not expected to generate any additional waste loads than those typical of a low impact industry.</p>

Performance Outcomes		Acceptable Outcomes	Compliance
		<p>g. covered, desirably within a shed but otherwise with weatherproof material.</p> <p>AND</p> <p>AO4.2</p> <p>The reuse of waste litter, manure and other organics as soil conditioners or fertilizers is not undertaken on-site.</p> <p>AND</p> <p>AO4.3</p> <p>Composting activities are not undertaken on-site.</p> <p>AND</p> <p>AO4.4</p> <p>Carcasses are not buried on-site except as required in accordance with any emergency animal disease directive by a biosecurity agency.</p>	
Wastewater			
PO5	Wastewater treatment systems are designed, constructed and managed in ways that do not compromise the drinking water supply environmental values.	<p>AO5.1</p> <p>Development does not involve an on-site wastewater facility.</p> <p>OR</p> <p>AO5.2</p>	<p>Complies: The on site wastewater treatment and effluent disposal system achieves a 'very low' risk classification in accordance with Seqwater's Land Use Risk Tool for on-site sewage facilities. Refer to Site and Soil Evaluation Report by Stav's Hydraulic Services and LURT Output in Appendix C and D respectively. The design capacity is less than 21 EP.</p>

Performance Outcomes	Acceptable Outcomes	Compliance
<p>Note: water supply environmental values are referenced within Schedule 1 of the Environmental Protection Policy (Water) 2009.</p>	<p>Where the combined total peak design capacity of wastewater treatment is less than 21 Equivalent Persons (EP), the design of the system achieves a Low or Medium Risk classification in accordance with Seqwater's <i>Land Use Risk Tool for on-site sewage facilities</i>.</p> <p>OR</p> <p>AO5.3</p> <p>Where the combined total peak design capacity of wastewater treatment is 21EP or greater, the system is located and designed in the following manner:</p> <ol style="list-style-type: none"> achieves a minimum secondary treatment standard with nutrient removal and disinfection; on land at or above the 0.5% AEP flood event; the hydraulic capacity of the system is five times the average dry weather flow (ADWF); no direct discharge of sewage to a waterway or water supply source occurs, unless during a bypass event that exceeds peak hydraulic capacity and sewage is screened and disinfected before release; where treated effluent will be used in irrigation, application is: 	

Performance Outcomes

Acceptable Outcomes

Compliance

	<ul style="list-style-type: none"> i. confined to a dedicated area of land suitably located and sized, and using irrigation practices that will not adversely affect groundwater and surface water quality; and ii. located on land at or above the 0.5% AEP flood event; and f. where the combined total peak design capacity of wastewater treatment is 1500EP or greater, and direct discharge to a waterway is the only reasonably practical disposal option, the contribution of flow from the system must be modelled over the range of reasonably expected flow events. If the proportion of flow is: <ul style="list-style-type: none"> i. <10% of the total flow, 3-log reduction bacteria and virus, and 4-log reduction protozoa, minimum pathogen log-reduction values apply; or ii. >10% of the total flow, it must demonstrate compliance with the Australian guidelines for water recycling (Phase 2): Augmentation of drinking water supply (to be undertaken in consultation with Seqwater). <p>Note: Developments involving the irrigation of wastewater will need to provide a MEDLI Modelling Report demonstrating the nominated land area for irrigation is suitably located and sized to</p>
--	--

Performance Outcomes		Acceptable Outcomes	Compliance
		accommodate design wastewater loads, storages are suitably sized to accommodate design wastewater loads and proposed irrigation practices will not result in any adverse impact on water quality. It is recommended the modelling exercise incorporate scenarios based on both a 10-year and 20-year planning horizon and incorporate a minimum of three irrigation concepts.	
Vegetation management			
PO6	Maintain the current extent of any vegetation located adjacent, or connected, to any waterway or water supply source.	AO6.1 Clearing complies with the following locational criteria: a) 25m setback to a stream order 1-3; b) 50m setback to a stream order 4 or greater; c) 200m setback to a full supply level of a dam, lake or reservoir or watercourse that serves as a potable water supply; d) is not undertaken on land within the 1% AEP flood event; and e) is not undertaken on a slope greater than 15%.	Complies: No clearing is proposed within the waterways or 50m setback of the waterways. The proposed development is not undertaken within the 1% AEP flood extent and is not undertaken on land with a slope greater than 15%.
Stormwater quality and hydrology			
PO7	Manage stormwater at the construction phase to protect drinking water supply environmental	AO7.1 At the construction stage, an erosion and sediment control program (ESCP) demonstrates that	Complies: A construction stage erosion and sediment control plans have been developed as part of this site based stormwater management

Performance Outcomes	Acceptable Outcomes	Compliance
<p>values and facilitate the achievement of water quality objectives for receiving waters.</p> <p>Note: Drinking water supply environmental values are referenced within Schedule 1 of the Environmental Protection Policy (Water) 2009.</p>	<p>stormwater achieves the design objectives listed in Table A of the SPP (appendix 2): <i>Construction Phase – Stormwater management design objectives</i> (all parts).</p> <p>OR</p> <p>AO7.2</p> <p>An ESCP demonstrates how stormwater quality will be managed at the construction stage in accordance with an acceptable regional or local guideline so that target contaminants are treated to a design objective at least equivalent to Table A of the SPP (all parts).</p> <p>OR</p> <p>AO7.3</p> <p>Stormwater run-off generated during construction is captured and transferred off-site or captured and treated to any applicable re-use standards and reused on-site.</p>	<p>plan. Refer to section 6 of this report and the proposal plans ACS-230068-GEN.</p>
<p>PO8</p> <p>Manage stormwater during operational (post-construction) stages to protect drinking water supply environmental values and facilitate the achievement of water quality objectives for receiving waters.</p> <p>Note: Drinking water supply environmental values are referenced within Schedule 1 of the Environmental Protection Policy (Water) 2009.</p>	<p>AO8.1</p> <p>Development does not involve an impervious area greater than 1,000m².</p> <p>OR</p> <p>AO8.2</p> <p>Development is for reconfiguring a lot that:</p>	<p>Complies: The proposed stormwater quality treatment train achieves the minimum reduction in mean annual loads (AO8.3) from the unmitigated development. Refer to section 5 of this report.</p>

Performance Outcomes	Acceptable Outcomes	Compliance
	<p>a) will not create more than two additional lots; or</p> <p>b) involves a land area less than 1000m².</p> <p>OR</p> <p>AO8.3</p> <p>Stormwater run-off generated during operation (post-construction) demonstrates a minimum reduction in mean annual load from unmitigated development that achieves the following stormwater management design objectives:</p> <ul style="list-style-type: none"> • 85% reduction in total suspended solids; • 65% reduction in total phosphorus; • 45% reduction in total nitrogen; and • 95% reduction in gross pollutants. <p>OR</p> <p>AO8.4</p> <p>Stormwater run-off generated during operation is captured and transferred off-site or captured and treated to any applicable re-use standards and reused on-site.</p> <p>Note: A Site Stormwater Quality Management Plan is to be prepared by a suitably qualified individual such as a Civil Engineer or an Environmental Professional and is to be certified by a Registered Professional Engineer (RPEQ)</p>	

Performance Outcomes		Acceptable Outcomes		Compliance	
PO9	Development maintains or improves the quality of surface water by adopting measures that exclude livestock from entering a water body where a site is being used for animal husbandry or animal-keeping activities.	(Civil or Environmental) to demonstrate compliance with the stormwater design objectives.	No acceptable outcome is nominated.	N/A: The proposed development does not include livestock.	
PO10	Development avoids and minimises changes to the existing surface water natural hydrological regime so that: <ul style="list-style-type: none"> a. there is no change to the reference high-flow and low-flow duration frequency curves, low-flow spells frequency curve and mean annual flow to and from waterways as a result of the development; b. any relevant flows into waterways comply with the relevant flow objectives of the applicable water plan for the area; and c. the collection and re-use of stormwater occurs so there is no increase to the velocity or volume of stormwater flows entering a waterway. 	No acceptable outcome is nominated.	No acceptable outcome is nominated.	Complies: As demonstrated in this report there is not expected to be any change to existing surface water natural hydrological regimes as a result of the proposed development. Existing flows will be maintained.	
PO11		No acceptable outcome is nominated.	No acceptable outcome is nominated.	N/A: No artificial waterways are proposed.	

Performance Outcomes	Acceptable Outcomes	Compliance
<p>The design and location of artificial waterways:</p> <ul style="list-style-type: none"> a. use natural channel design principles to minimise erosion, flooding and maintenance while maximising ecological and aesthetic values of waterways; b. are compatible with any existing natural waterways; and c. are designed to ensure surface water hydrological regimes are maintained. 	<p>Note: The Ipswich City Council Waterway and Channel Rehabilitation Guidelines or Brisbane City Council Natural Channel Design Guidelines demonstrate suitable natural channel design works.</p>	
<p>PO12</p> <p>Development maintains the existing groundwater hydrological regime.</p>	<p>AO12.1</p> <p>Development does not change the existing groundwater hydrological regime by lowering or raising the water table and hydrostatic pressure outside the bounds or variability of existing predevelopment conditions.</p> <p>AND</p> <p>AO12.2</p> <p>Development does not result in the ingress of saline water into freshwater aquifers.</p> <p>Note: Where development is likely to impact on the water table, a hydrological assessment undertaken by a suitably qualified professional may be required to demonstrate no adverse impact on the groundwater hydrological regime.</p>	<p>Complies: The proposed development is not expected to change existing groundwater hydrological regimes.</p>
<p>Excavation and filling</p>		

Performance Outcomes		Acceptable Outcomes	Compliance
<p>PO13</p> <p>The siting and design of earthworks minimises impacts on the natural landform that may cause contamination or interfere with the flow of a waterway or water supply source.</p>	<p>AO13.1</p> <p>Earthworks comply with the following locational criteria:</p> <ul style="list-style-type: none"> a. 25m setback to a stream 1-3; b. 50m setback to a stream order 4 or greater; c. 200m setback to a full supply level of a dam, lake or reservoir or watercourse which serves as a potable water supply; d. is not undertaken on land at or below the 1% AEP; and; e. is not undertaken on a slope greater than 15%. 	<p>Complies: Earthworks comply with the locational criteria and further an erosion and sediment control plan has been prepared in accordance with best practice which if followed will minimise movement of sediment off site.</p>	
<p>PO14</p> <p>Any earthworks minimise erosion and the movement of sediment off-site.</p> <p>Note: A Sediment and Erosion Control Plan is to be prepared by a suitably qualified and experienced professional in accordance with best practice such as IECA 2008, Best Practice Erosion and Sediment Control.</p>	<p>No acceptable outcome is nominated.</p>	<p>Complies: An erosion and sediment control plan has been prepared in accordance with best practice which if followed will minimise movement of sediment off site.</p>	
Dangerous goods, hazardous substances or environmentally hazardous materials			
<p>PO15</p> <p>Dangerous goods, hazardous substances or environmentally hazardous materials are</p>	<p>AO15.1</p> <p>The storage or handling of dangerous goods, hazardous substances or environmentally</p>	<p>Complies: Dangerous goods, hazardous substances or environmentally hazardous materials greater than a 200L or 200kg quantity may be stored or handled on site. All dangerous</p>	

Performance Outcomes	Acceptable Outcomes	Compliance
<p>stored and handled in a manner that minimises the potential for contamination of surface and groundwater in the event of a leak or spill.</p>	<p>hazardous materials involves an aggregate quantity less than 200L or 200kg.</p> <p>OR</p> <p>AO15.2</p> <p>The storage or handling of dangerous goods, hazardous substances or environmentally hazardous materials with an aggregate quantity greater than 200L or 200kg and less than 1000L or 1000kg maintains the following separation distances:</p> <ul style="list-style-type: none"> a. 100m to a minor waterway; b. 100m to a stream order 4 or greater; and c. 800m to a full supply level of a dam, lake or reservoir or watercourse that serves as a potable water supply. <p>AND</p> <p>AO15.3</p> <p>Dangerous goods, hazardous substances or environmentally hazardous materials are located and stored in the following manner:</p> <ul style="list-style-type: none"> a. is not undertaken on land within the 1% AEP flood event; b. undercover in a building or similar structure; 	<p>goods, hazardous substances or environmentally hazardous materials will be appropriately stored within the heavy machinery shed located more than 100m from any waterways, above the 1% AEP and banded via secondary containment to recover spills and in accordance with in accordance with Australian Standard AS 1940-2004: The Storage and Handling of Flammable and Combustible Liquids.</p> <p>The storage of petroleum products in bulk (greater than 1000L) will be aboveground in self-banded vessels that meet <i>Australian Standard AS 1692 Steel Tanks for Flammable and Combustible Liquids</i>.</p>

Performance Outcomes	Acceptable Outcomes	Compliance
	<p>c. in or on a dedicated impervious secondary containment store or device that permits full recovery of spills;</p> <p>d. in a manner that prevents the movement of packages/containers from their place of storage during a flood event; and</p> <p>e. in accordance with Australian Standard AS 1940-2004: The Storage and Handling of Flammable and Combustible Liquids.</p> <p>OR</p> <p>AO15.4</p> <p>The storage of dangerous goods, hazardous substances or environmentally hazardous materials (other than petroleum products) in aggregate quantities greater than 1000L or 1000kg is not undertaken unless a site-specific risk assessment presents minimal risk to drinking water quality.</p> <p>For petroleum products only:</p> <p>AO15.5</p> <p>The storage of petroleum products in bulk (greater than 1000L) aboveground uses self-bunded vessels that meet <i>Australian Standard AS 1692 Steel Tanks for Flammable and Combustible Liquids</i>.</p> <p>OR</p>	

Performance Outcomes	Acceptable Outcomes	Compliance
	<p>AO15.6</p> <p>The storage of petroleum products in bulk (greater than 1000L) aboveground uses single-skin vessels installed within a banded compound that:</p> <ul style="list-style-type: none"> a. is sufficiently impervious (permeability should be <10-9 m/s) to retain and recover spillage; and b. has a net capacity of at least 100% of the banded vessel or aggregate quantity of vessels where operated as a single unit. <p>OR</p> <p>AO15.7</p> <p>Petroleum products belowground (greater than 200L) are stored in vessels that are non-corrodible, double walled with an interstitial space between, and meet the requirements of Australian Standard AS 1692: <i>Steel Tanks for Flammable and Combustible Liquids</i> and/or UL 1316 <i>Glass fibre reinforced plastic underground storage tanks for petroleum products, alcohols and alcohol gasoline mixture</i>.</p>	
Material change of use for extractive industry only		
<p>PO16</p> <p>Extraction activities do not impact on erosion, natural fluvial processes, river bank stability or the storage capacity volume of a floodplain.</p>	<p>No acceptable outcome is nominated.</p>	<p>N/A: The proposed development does not involve an extractive industry.</p>

Performance Outcomes		Acceptable Outcomes	Compliance
For reconfiguring a lot only			
<p>PO17</p> <p>When reconfiguring a lot, all resultant lots requiring an on-site wastewater treatment system do not compromise the environmental values of drinking water supply.</p> <p>Note: Drinking water supply environmental values are referenced within Schedule 1 of the Environmental Protection Policy (Water) 2009.</p>	<p>AO17.1</p> <p>Any new lot can accommodate an area for on-site wastewater treatment and disposal complying with the following:</p> <ul style="list-style-type: none"> a. 50m setback to a stream order 1-3; b. 100m setback to a stream order 4 or greater; and c. 400m setback to a full supply level of a dam, lake or reservoir or watercourse that serves as a potable water supply. <p>AND</p> <p>AO17.2</p> <p>Any new lot can accommodate an area for on-site wastewater treatment and disposal on land that is not within the 1% AEP flood event and on a slope at or less than 10%.</p> <p>AND</p> <p>AO17.3</p> <p>Any proposed lots that are to accommodate a future on-site wastewater system, maintain an average lot size of at least 2.5 ha.</p>	<p>N/A: The proposed development does not involve the reconfiguration of any lots.</p>	

Performance Outcomes	Acceptable Outcomes	Compliance
	<p>Note: A wastewater site analysis is to be prepared by a suitably qualified professional demonstrating the above.</p>	

Appendix C) Effluent Disposal Report

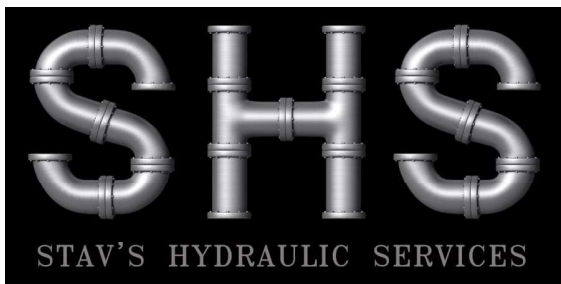

STAV'S HYDRAULIC SERVICES
ABN: 64 467 212 730
QBCC: 15061807
stephen@stavs.com.au
www.stavs.com.au
0402 303 599

SITE & SOIL EVALUATION REPORT 149 SANDY CREEK ROAD, BROMELTON

Prepared for:	Beaudesert & Boonah Cranes
Prepared by:	Stav's Hydraulic Services
Purpose:	Site & Soil Evaluation Report
Issue No:	E
Date Issued:	23-Oct-24
Author:	Stephen Stavrinou

1. Contents

2. Intro..... 3

3. Executive summary..... 3

4. Site Investigation 4

5. Effluent Quality and Control Parameters 4

6. Design Calculations 5

7. Operation and Maintenance 7

8. Appendix A - Land application area plan..... 8

2. Intro

Stav's Hydraulic Services have carried out a Site and Soil Evaluation for the On-Site waste water treatment and the effluent disposal at Lot 3 on RP40309 - 149 Sandy Creek Road Bromelton, Qld.

The following report has been prepared in accordance with AS/NZS1547:2012, On-Site Domestic Waste Water Management and the Queensland Plumbing and Waste Water Code.

3. Executive summary

The recommendation and comments:

1. Use an Advanced Secondary all-waste sewage system such as the Envirocycle 10EP advanced Secondary Wastewater treatment system for the proposed sheds 1-4
2. Remove the existing greywater pump out and black water septic systems for the existing residence and replace with new Envirocycle 10EP advanced Secondary Wastewater treatment system
3. The peak daily design volume for the entire site is 13.3 Equivalent persons – 2,000l/day – loads from existing residence & proposed sheds 1 – 4.
4. Soil is a densely structured category 5 – Clayey Sand, Low Plasticity, Fine Grained, yellow - Design Irrigation Rate (DIR) = 21 mm / week
5. Total land application to be comprised of a land application area of 667m² spread across 5 systems.
6. Have warning signs, complying with AS1319 at the boundaries of the designated area in two places and clearly visible to property users with wording such as “Recycled Water – Avoid Contact – DO NOT DRINK”
7. On-site sewage systems are not designed to cope with the flow from garbage grinders, fats, oils or chemicals and household cleaning products are to be used in accordance with their labels.
8. The land application area is an important area and has to be maintained e.g. regularly mowed, do not drive vehicles over the area or allow livestock to access the land application area Follow the maintenance requirements specified by the manufacturer and authorised service agent.

4. Site Investigation

Site Investigation	
Date of Investigation	20.09.2023
Address	149 Sandy Creek Road Bromelton
Area of Site	40,170m ²
Property Description	Lot 3 on RP40309
Local Council	Scenic Rim Regional Council
Weather	Fine
Ground Cover	Grass
Well/Bores	1
Waterways	Nil
Water Table	Nil
Embankments	Nil
Buildings	Existing Residence and sheds to western corner
Site Exposure	Full Sunlight
Boundaries	Sufficient
Landscape Description	Waxing Divergent
Diversion / Retention Mound	Nil
Ground Water Cut off drains	Nil
Intended Water Supply	Rain Water

Soil Characteristics	
Depth	0-600mm
Texture - structure - Colour	Silty Sand Loam in the top layers that increase in clay content with depth
Soil Category	5
Indicative permeability (Ksat) m/day	0.06
Design Irrigation Rate (DIR) mm/week	21
Design Loading Rate (DLR) mm/week	30

5. Effluent Quality and Control Parameters

Effluent Quality Parameters			
Parameter	Primary	Secondary	Advanced Secondary
Bod ₅	120-240	20	10
Total Suspended Solids (mg/L)	65-180	30	10
Thermotolerant Coliforms (org/100mL)	N/A	200	10

6. Design Calculations

Design Loadings - Existing Residence			
No. of Bedrooms	3		
Equivalent Persons (EP)	4		
Desing Flow L/day	150	Rainwater	
Daily flow / Weekly Flow	600	/	4200
Design Irrigation Rate (DIR) mm/week	21		
Land Application Area (m ²)	200 m ²	Adopt	200 m ²
Design Loadings - Shed 1			
No. of Staff	10		
Desing Flow L/day	30	Tank Water Supply	
Wash Bay Design Flow rate / No washes	100 L per wash	2 Per Day	
Desing Flow L/day	30	Tank Water Supply	
Daily flow / Weekly Flow	500	/	3500
Design Loading Rate (DIR) mm/week	21		
Land Application Area (m ²)	166.6666667 m ²	Adopt	167 m ²
Design Loadings - Shed 2			
No. of Staff	10		
Desing Flow L/day	30	Tank Water Supply	
Daily flow / Weekly Flow	300	/	2100
Design Loading Rate (DIR) mm/week	21		
Land Application Area (m ²)	100 m ²	Adopt	100 m ²
Design Loadings - Shed 3			
No. of Staff	10		
Desing Flow L/day	30	Tank Water Supply	
Daily flow / Weekly Flow	300	/	2100
Design Loading Rate (DIR) mm/week	21		
Land Application Area (m ²)	100 m ²	Adopt	100 m ²
Design Loadings - Shed 4			
No. of Staff	10		
Desing Flow L/day	30	Tank Water Supply	
Daily flow / Weekly Flow	300	/	2100
Design Loading Rate (DIR) mm/week	21		
Land Application Area (m ²)	100 m ²	Adopt	100 m ²

149 Sandy Creek Road, Bromelton

Site & Soil Evaluation Report

Rev:P1 | Date: 23-Oct-24

TOTAL DESIGN LOADINGS FOR SITE	
Daily flow / Weekly Flow	2000 / 14000
Equivalent population	13.33333333

Bod5 Applied - Total Site	
Bod5 Applied 10mg / litre/ day	5.037 kg/year
Soil Absorption Only	0.05kg / m ² / year
Minimum land Application Area	100.74 m ²

The proposed wastewater system utilises an Advanced Secondary all-waste sewage treatment plant - Envirocycle 10EP advanced Secondary Wastewater treatment system for proposed sheds 1 -4 & also existing residence.

The Proposed systems will discharge to separate sub surface drippers as per below calculations.

Compensating Dripper Calculations - Existing Residence	
Compensation Dripper area / laterals	200 m ² 20 m lateral length
No. of Laterals and Spacing's	10 1 m centres
Dripper Hole spacing	0.5 m dripper hole spacing
Compensating dripper flow rate	2.5 l/hour dripper rate
Effluent Flow Rate	4000 l/hour

The existing residence currently discharges to separate greywater pump out and black water septic systems. These systems are proposed to be removed and replaced with new Advanced Secondary all-waste sewage treatment plant - Envirocycle 10EP advanced Secondary Wastewater treatment system.

Compensating Dripper Calculations - Shed 1	
Compensation Dripper area / laterals	167 m ² 30 m lateral length
No. of Laterals and Spacing's	6 1 m centres
Dripper Hole spacing	0.5 m dripper hole spacing
Compensating dripper flow rate	2.5 l/hour dripper rate
Effluent Flow Rate	1859 l/hour

Shed 1 also incorporates a wash bay discharge into an inground oil water separator for pretreatment before discharging to the wastewater treatment plant.

Compensating Dripper Calculations - Sheds 2 - 3	
Compensation Dripper area / lateral length	100 m ² 20 m lateral length
No. of Laterals and Spacing's	5 1 m centres
Dripper Hole spacing	0.5 m dripper hole spacing
Compensating dripper flow rate	2.5 l/hour dripper rate
Effluent Flow Rate	3226 l/hour

Compensating Dripper Calculations - Shed 4	
Compensation Dripper area / lateral length	100 m ² 32 m lateral length
No. of Laterals and Spacing's	4 1 m centres
Dripper Hole spacing	0.5 m dripper hole spacing
Compensating dripper flow rate	2.5 l/hour dripper rate
Effluent Flow Rate	3226 l/hour

AS1547 states that:

- a. The effluent is required to be evenly distributed within the designated area.
- b. Have warning, complying with AS1319 at the boundaries of the designated area in two places and clearly visible to property users with wording such as "Recycled Water – Avoid Contact – DO NOT DRINK"
- c. Ensure that the effluent does not come into contact with people, domestic animals, fruit or vegetables for human consumption

7. Operation and Maintenance

Maintenance requirements specified by the manufacturer and authorized service agent are to be implemented. These include:

- Use low sodium biodegradable soaps and detergents
- No paints, solvents, chemicals, food scraps, fats, oils or any other solids are not to be disposed of "down the drain"
- On-site sewage systems are not designed to cope with the flow from garbage grinders
- The land application area is an important area and has to be maintained e.g. regularly mowed or pruned also ensuring that there is no ponding of effluent in the disposal area
- Vehicles, livestock or general access is to be generally restricted with warning signs erected

8. Appendix A - Land application area plan

EFFLUENT DISPOSAL

149 SANDY CREEK ROAD
BROMELTON, QLD



DRAWING LIST

- H101 - COVER SHEET & LOCATION PLAN
- H102 - LEGEND, NOTES & DETAILS
- H103 - SITE PLAN EFFLUENT DISPOSAL LAYOUT

PROJECT LOCATION



LOCATION PLAN
NOT TO SCALE

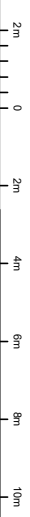

ISSUE	AMENDMENT	DATE
A	APPROVAL ISSUE	13.10.2023
B	APPROVAL ISSUE	16.10.2024

CLIENT:
**BEAUDESERT &
BOONAH CRANES**

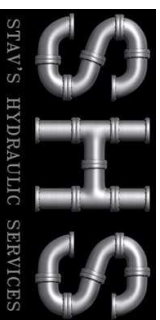

07 5623 4177
www.shs.com.au
shs@shs.com.au
PO Box 529,
Jilmbomba, QLD

PROJECT:
**LOT 3 ON RP40309
149 SANDY CREEK ROAD
BROMELTON, QLD**

TITLE:
**HYDRAULIC SERVICES
COVER SHEET & LOCATION PLAN**

PROJECT No.	BBC1	DRAWING No.	H101	ISSUE No.	B
SCALE / SIZE:	N.T.S @ A3				

- GENERAL**
- ALL WORK TO BE CARRIED OUT IN ACCORDANCE WITH THE REQUIREMENTS OF AS3500, THE BUILDING CODE OF AUSTRALIA, RELEVANT AUSTRALIAN STANDARDS AND THE LOCAL AUTHORITY REQUIREMENTS.
 - THESE PLANS SHALL BE READ IN CONJUNCTION WITH THE APPROVED ARCHITECTURAL AND RELEVANT SERVICES PLANS AND SPECIFICATIONS
 - LOCATION OF EXISTING SERVICES HAS BEEN DETERMINED FROM SITE VISITS AND EXISTING RECORD PLANS. NO PROVING OF SERVICES HAS BEEN UNDERTAKEN. THE CONTRACTOR SHALL PROVE ALL SERVICES PRIOR TO COMMENCING CONSTRUCTION AND ADVISE THE SUPERINTENDENT OF ANY DISCREPANCIES BEFORE PROCEEDING. THIS CONTRACTOR MUST CO-ORDINATE WITH ALL OTHER SERVICES. PIPEWORK SHOWN ON THIS DRAWING IS DIAGRAMMATIC ONLY. FINAL LOCATION OF SERVICES SHALL BE DETERMINED ON SITE.
 - ARRANGE & APPLY TO THE LOCAL AUTHORITY FOR ALL NECESSARY PERMITS. PAY ALL PLUMBING INSPECTION FEES AND CHARGES. OBTAIN COMPLETION CERTIFICATE AND SUBMIT TO SUPERVISOR.
 - THE ENTIRE HYDRAULIC SERVICES INSTALLATION AND EQUIPMENT SHALL BE MAINTAINED UNDER WARRANTY FOR A PERIOD OF TWELVE (12) MONTHS AFTER PRACTICAL COMPLETION HAS BEEN ACHIEVED.
 - PROVIDE INSTRUCTIONS MANUALS AT PRACTICAL COMPLETION, CONTAINING THE FOLLOWING:
 - GENERAL DESCRIPTION OF PROJECT
 - LISTING OF EQUIPMENT, MANUFACTURERS NAMES, AGENTS ETC.
 - OPERATING AND MAINTENANCE INSTRUCTIONS AND WARRANTY INFORMATION FOR EACH ITEM OF EQUIPMENT.
 - "AS CONSTRUCTED" DRAWINGS.
 - COUNCIL INSPECTION REPORTS AND FINAL COMPLETION CERTIFICATES FROM RELEVANT AUTHORITIES.

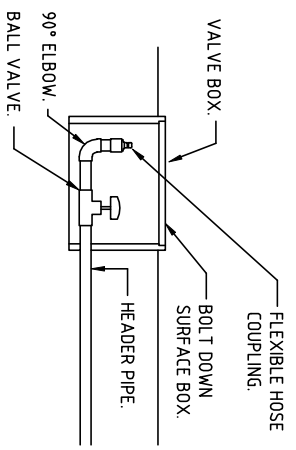

FLUSHING VALVE DETAIL
SCALE: NTS

WATER

- ALL EXPOSED HW & CW PIPEWORK SHALL BE COPPER TUBE TYPE "B" TO AS1432. CONNECT COPPER PIPE WITH BRAZED JOINTS IN AS1645 OR COMPRESSION JOINTS AS1585. USE PRE-INSULATED PIPEWORK FOR HOT WATER SERVICES OR INSULATE WITH ARMAFLEX INSULATION OR SIMILAR. DEMO WRAP ALL CW PIPEWORK IN-GROUND. PROVIDE INSULATION TO ALL HOT WATER PIPEWORK. PROVIDE ALL NECESSARY ALLOWANCES FOR THERMAL MOVEMENT OF PIPES.
- WATER SUPPLY PIPEWORK CONCEALED IN WALLS AND EXTERNAL TO BUILDING IN-GROUND MAY BE POLYETHYLENE PIPE OF MIN. CLASS 12, AND SHALL COMPLY WITH AS 1159. INSTALLATION OF POLYETHYLENE PIPES SHALL BE IN ACCORDANCE WITH AS 2033 AND THE MANUFACTURERS SPECIFICATIONS.
- TAKE ALL NECESSARY PRECAUTIONS TO PREVENT WATER HAMMER AND RECTIFY SHOULD IT OCCUR.
- EXTERNAL AND INTERNAL HOSE COCKS SHALL BE FITTED WITH HOSE TYPE VACUUM BREAKERS.
- PROVIDE HW & CW STOPCOCKS TO ALL HW & CW FIXTURES.
- ALL PIPEWORK TO BE IDENTIFIED IN ACCORDANCE WITH AS1345.
- ALL PIPE DIAMETERS NOMINATED ARE NOMINAL BORE DIAMETERS UNLESS NOTED OTHERWISE.

ON SITE DISPOSAL NOTES

- IRRIGATION SYSTEM TO COMPLY WITH AS1547, QLD PLUMBING WASTE WATER CODE, ASSOCIATED DOCUMENTATION AND MANUFACTURERS SPECIFICATIONS.
- MINIMUM COVER OVER RISING MAIN 450mm. RISING MAINS TO BE 32Ø PIPES TO AS/NZS 14.77. PIPE TO BE LILAC COLORED AND/OR INSTALLED WITH TAPE IDENTIFYING THE PIPES CONTENTS AS SEWAGE EFFLUENT.
- IRRIGATION SYSTEMS DISTRIBUTE EFFLUENT INTO THE TOPSOIL LAYERS TO PROVIDE IN-SOIL TREATMENT OF THE REMAINING EFFLUENT RESIDUALS AS WELL AS PROVIDE NUTRIENT UPTAKE AND EVAPOTRANSPIRATION BY GRASS, SHRUBS OR PLANTINGS. THE CHOSEN GRASS, SHRUBS OR PLANTINGS SHALL BE PLANTED/SEEDED PRIOR TO THE COMMISSIONING OF THE SYSTEM TO ALLOW FOR PROPER EFFLUENT DISPOSAL.

DRAINAGE

- SANITARY DRAINAGE & VENT PIPEWORK IN UPVC IN ACCORDANCE WITH AS1260 AND THE MANUFACTURERS SPECIFICATIONS.
- ALL PIPEWORK TO BE IDENTIFIED IN ACCORDANCE WITH AS1345.
- ALL PIPE DIAMETERS NOMINATED ARE NOMINAL BORE DIAMETERS UNLESS NOTED OTHERWISE.

LEGEND

—R—R—	PUMPED EFFLUENT
—	SANITARY DRAINAGE PIPEWORK
- - - - -	VENT PIPEWORK
- - - - -	STORMWATER PIPEWORK
- . . . - . . . -	COLD WATER PIPEWORK
- - - - -	HOT WATER PIPEWORK

⊠	VALVE
AFFL	ABOVE FINISHED FLOOR LEVEL
AHD	AUSTRALIAN HEIGHT DATUM
B	BASIN
CD	CONDENSATE DRAIN
COS	CLEAR OUT TO SURFACE
Cu	COPPER PIPE
CW	COLD WATER
CV	CONTROL VALVE
DP	DOWN PIPE
DW	DISHWASHER
e	EXISTING TO REMAIN
FFL	FINISHED FLOOR LEVEL
FW	FLOOR WASTE GULLY
H/L	HIGH LEVEL
HC	HOSE COCK c/w KEY OPERATED HANDLE
HW	HOT WATER
HWH	HOT WATER HEATER
IC	INSPECTION CHAMBER
IO	INSPECTION OPENING
L/L	LOW LEVEL
ORG	OVERFLOW RELIEF GULLY
SHR	SHOWER
SK	SINK
WC	WATER CLOSET
VB	VACUUM BREAKER

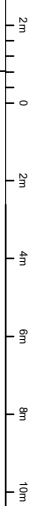

ISSUE	AMENDMENT	DATE
A	APPROVAL ISSUE	13.10.2023
B	APPROVAL ISSUE	16.10.2024

CLIENT: **BEAUDESERT & BOONAH CRANES**

CONSULTANT: **SHS**
STAV'S HYDRAULIC SERVICES
07 5623 4177
www.shs.com.au
shs@shs.com.au
PO Box 629, Jilthonbada, Qld

PROJECT: **LOT 3 ON RP40309 149 SANDY CREEK ROAD BROMELTON, QLD**

TITLE: HYDRAULIC SERVICES LEGEND, NOTES & DETAILS	
PROJECT No.	BBC1
DRAWING No.	H102
ISSUE No.	B
SCALE / SIZE:	NTS @ A3

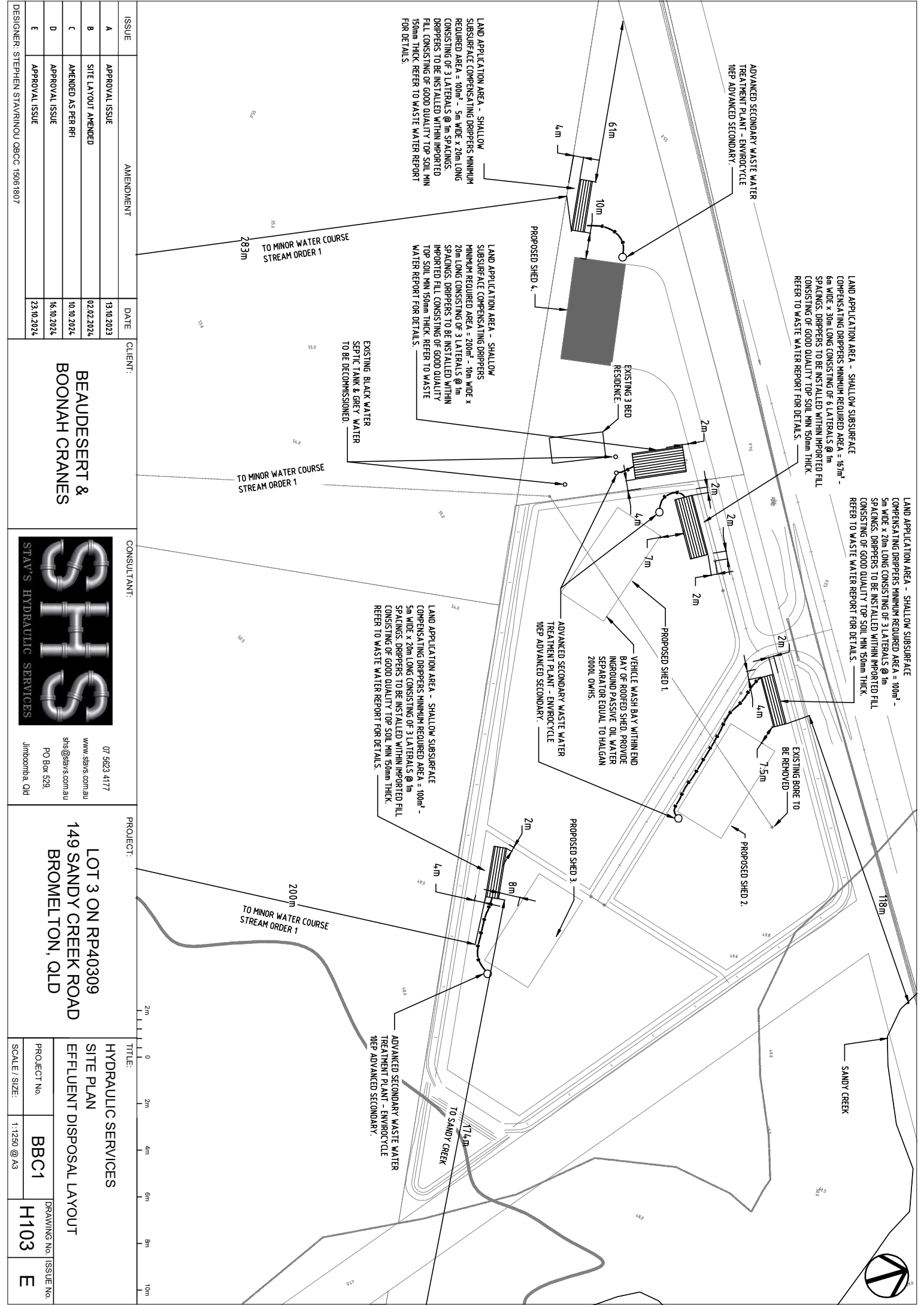

ISSUE	AMENDMENT	DATE
A	APPROVAL ISSUE	13.10.2023
B	SITE LAYOUT AMENDED	02.02.2024
C	AMENDED AS PER RFI	10.10.2024
D	APPROVAL ISSUE	16.10.2024
E	APPROVAL ISSUE	23.10.2024

CLIENT:
**BEAUDESERT &
 BOONAH CRANES**



07 5623 4177
 www.stavs.com.au
 shs@stavs.com.au
 PO Box 629,
 Jilthonbha, Qld

PROJECT:
**LOT 3 ON RP40309
 149 SANDY CREEK ROAD
 BROMELTON, QLD**

TITLE: HYDRAULIC SERVICES SITE PLAN EFFLUENT DISPOSAL LAYOUT	
PROJECT No.	BBC1
DRAWING No. / ISSUE No.	H103 / E
SCALE / SIZE:	1:1250 @ A3

DESIGNER: STEPHEN STAVINOU QBCC 15061807

Appendix D) LURT Output

Rating Details

Property Owner Details

Property Owner:	"Beaudesert & Boonah Cranes C/- ACS Engineers (Aust) Pty Ltd"			
Postal Address:	"PO Box 554"	"Beaudesert"	"QLD"	"4285"
Phone Number:	"07 5541 3500"	Mobile Number:	""	
Email:	"holly@acsengineers.com.au"			

Property Details

Street Address:	"149 Sandy Creek Road"	"Bromelton"	"QLD"	"4285"
Latitude:	""	Longitude:	""	
Lot Number:	""	Plan Number:	""	
Area (m2):	"40170"	Local Government:	"Scenic Rim Regional Council"	

Rating Risk Rating Questionnaire

Unmitigated Score	No further mitigation required	Mitigated Score
4		0
VERY LOW		
Calculating Unmitigated Risk		
1	<p>Does the disposal area and wastewater treatment system maintain the following separation distances (AND):</p> <ul style="list-style-type: none"> • At least 100m to the nearest watercourse (permanent and non-permanent)? • At least 400m from the full supply level of a potable water supply? <p>Please note: Potable water supply includes any dam, bore, reservoir or conduit used for direct extraction of water for drinking water purposes.</p>	Yes
2	<p>Is the disposal area or the wastewater treatment system (OR):</p> <ul style="list-style-type: none"> • Less than 50m to the nearest watercourse (permanent and non-permanent)? • Less than 200m from the nearest full supply level of a potable water supply? <p>Please note: Potable water supply includes any dam, bore, reservoir or conduit used for direct extraction of water for drinking water purposes.</p>	N/A
3	Is the disposal area of wastewater treatment system located inside of a defined flood event (Council or State mapping), at a minimum being 1% Annual Exceedance Probability (AEP)?	No
4	What is the maximum slope of the disposal area or wastewater treatment system location?	<5%
5	How many bedrooms are serviced by the proposed wastewater treatment system?	3 or more bedrooms
6	Is the indicative permeability range higher than 1m/day?	No
7	Is the separation distance to the water table/bedrock as specific for the type of system and at a minimum 1m below the disposal depth?	Yes
8	Is the dwelling a permanent or holiday residence?	Permanent Residence
9	Is the indicative drainage class either poorly drained (Soil Category 5) or very poorly drained (Soil Category 6), as defined in Australian Standard AS1547?	Yes
10	Does the proposal involve composting?	No composting
11	Please select an irrigation method.	Subsurface
12	Please select the proposed treatment method.	Aerated
13	Does the system propose the diversion or re-use of greywater?	No
Mitigation Reduction: 6		

Model Conditions

Here are your draft conditions!

1	The poor drainage of the soil necessitates an appropriate depth of topsoil over the proposed effluent disposal area. Either soil remediation (gypsum / scarification) or clean imported topsoil must be provided to a depth of 150mm – 250mm over the disposal area and scarified into soils over the entire disposal area to ensure adequate drainage and reduction of nutrients.
2	The wastewater treatment system must be an advanced secondary wastewater treatment system with Chief Executive approval from the Department of Energy and Public Works and incorporate chlorination. The wastewater treatment system and disposal area must be designed operated and maintained in accordance with manufacturers specifications and the submitted Wastewater Design Report.
3	The disposal area must be planted with kikuyu grass or other native vegetation which provides a high uptake of nitrogen and phosphorus and prevents erosion.
4	The disposal area must incorporate appropriate diversion drainage above the disposal area (to prevent stormwater inundation) and bunds below the disposal area to reduce the risk of waterway contamination.
5	To minimise the risk of failure or inefficiency, the wastewater treatment system and disposal area must be inspected and serviced by an appropriately qualified professional in accordance with the manufacturer's recommendations and at least annually.
6	Ensure that larger deep-rooting plants and trees which may block sunlight are not planted near the disposal area to reduce the chance of root intrusion and clogging and maximise sun exposure.
7	A 100% reserve area is reserved and maintained on-site to allow for an alternative disposal location in case of land application area failure, malfunction or loss of soil uptake capacity. The reserve area must be kept clear of buildings, structures, vehicular movement paths or other activities which may otherwise affect its use for effluent disposal in the future.
8	No vehicular, machinery or domestic animal traffic movement is to occur over the disposal area, to maintain the integrity and function of sub-surface pipelines. Barriers such as fencing or shrubs are to be used when necessary.
9	The design must incorporate a warning system to notify of pump failure and/or high water level comprising of a highly visible strobe warning light at the tank and an internal alarm mounted in the house comprising of an audible and visual. A licenced plumber/service provider must be contacted as soon as practical after an alarm activates to rectify the issue.
10	The treatment system must incorporate contingency components including a backup pump stored appropriately on the site.

Appendix E) Rational Method Calculations

Name	Pre-Developed	Post-Developed
Catchment Area (ha)	4.02	4.02
Stream Length (m)		196
Sheet flow length (m)	285	165
Slope (%)	2	2
Hortons N Value	0.05	0.03
Tc Sheet flow	30.59	15.30
Tc channel flow	0.0	4.7
Total time of conc. (tc)	31.0	20.0

Rainfall Intensities

63%	45.9	59.1
50%#	52.0	67.0
20%*	71.0	91.5
10%	83.9	108.0
5%	96.5	124.0
2%	113.1	144.8
1%	125.9	160.6

Rainfall Depth

63%	23.7	19.7
50%#	26.9	22.3
20%*	36.7	30.5
10%	43.3	36.0
5%	49.8	41.3
2%	58.5	48.3
1%	65.1	53.5
Fraction impervious	0.00	0.33
C10 runoff coefficient	0.69	0.69

Frequency Factors

FF, 1-year	0.8	0.8
FF, 2-year	0.85	0.85
FF, 5-year	0.95	0.95
FF, 10-year	1	1
FF, 20-year	1.05	1.05
FF, 50-year	1.15	1.15
FF, 100-year	1.2	1.2

Flow Calculations

63.2% (m ³ /s)	0.283	0.365
50% (m ³ /s)	0.341	0.439
20% (m ³ /s)	0.520	0.670
10% (m ³ /s)	0.646	0.832
5% (m ³ /s)	0.781	1.003
2% (m ³ /s)	1.003	1.283
1% (m ³ /s)	1.164	1.485

Appendix F) Outflow Hydrographs

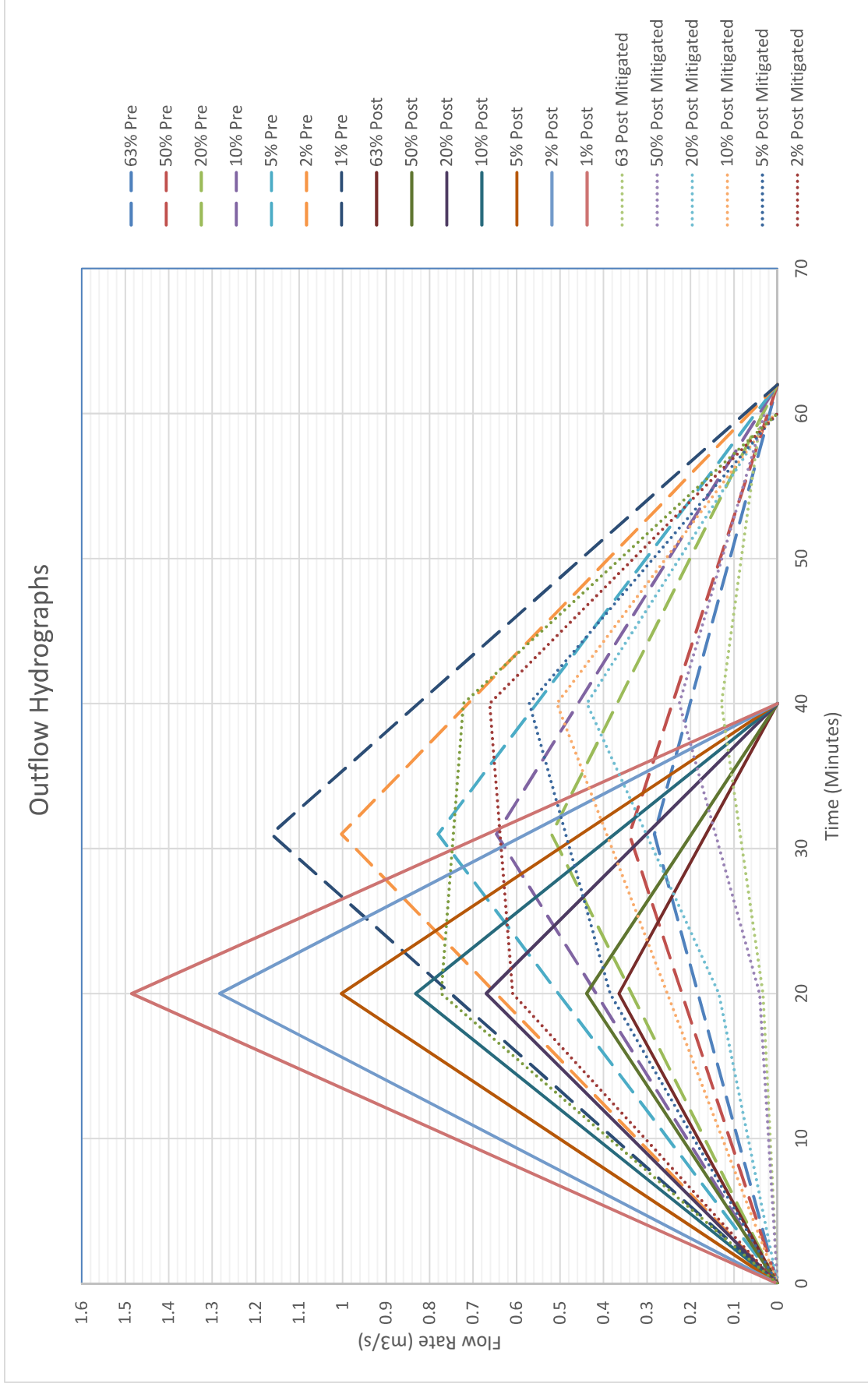

Appendix G) MUSIC Modelling Report

Source nodes

Location, Shed and Office Roof, Hardstand Gravel, Hardstand Sealed, Landscaped Area

ID, 2, 3, 4, 7

Node Type, UrbanSourceNode, UrbanSourceNode, UrbanSourceNode, UrbanSourceNode

Zoning Surface Type, Roof, Industrial, Industrial, Industrial

Total Area (ha), 0.344, 0.51, 0.6, 2.566

Area Impervious (ha), 0.344, 0.456183582089552, 0.597738805970149, 0

Area Pervious (ha), 0, 0.0538164179104478, 0.0022611940298507, 2.566

Field Capacity (mm), 80, 80, 80, 80

Pervious Area Infiltration Capacity coefficient - a, 243, 243, 243, 243

Pervious Area Infiltration Capacity exponent - b, 0.6, 0.6, 0.6, 0.6

Impervious Area Rainfall Threshold (mm/day), 1, 1, 1, 1

Pervious Area Soil Storage Capacity (mm), 48, 18, 18, 18

Pervious Area Soil Initial Storage (% of Capacity), 10, 10, 10, 10

Groundwater Initial Depth (mm), 50, 50, 50, 50

Groundwater Daily Recharge Rate (%), 0, 0, 0, 0

Groundwater Daily Baseflow Rate (%), 31, 31, 31, 31

Groundwater Daily Deep Seepage Rate (%), 0, 0, 0, 0

Stormflow Total Suspended Solids Mean (log mg/L), 1.3, 2.43, 2.43, 1.92

Stormflow Total Suspended Solids Standard Deviation (log mg/L), 0.44, 0.44, 0.44, 0.44

Stormflow Total Suspended Solids Estimation

Method, Stochastic, Stochastic, Stochastic, Stochastic

Stormflow Total Suspended Solids Serial Correlation, 0, 0, 0, 0

Stormflow Total Phosphorus Mean (log mg/L), -0.89, -0.3, -0.3, -0.59

Stormflow Total Phosphorus Standard Deviation (log mg/L), 0.36, 0.36, 0.36, 0.36

Stormflow Total Phosphorus Estimation

Method, Stochastic, Stochastic, Stochastic, Stochastic

Stormflow Total Phosphorus Serial Correlation, 0, 0, 0, 0

Stormflow Total Nitrogen Mean (log mg/L), 0.25, 0.25, 0.25, 0.25

Stormflow Total Nitrogen Standard Deviation (log mg/L), 0.32, 0.32, 0.32, 0.32

Stormflow Total Nitrogen Estimation

Method, Stochastic, Stochastic, Stochastic, Stochastic

Stormflow Total Nitrogen Serial Correlation, 0, 0, 0, 0

Baseflow Total Suspended Solids Mean (log mg/L), 1.1, 0.78, 0.78, 0.78

Baseflow Total Suspended Solids Standard Deviation (log mg/L), 0.17, 0.45, 0.45, 0.45

Baseflow Total Suspended Solids Estimation

Method, Stochastic, Stochastic, Stochastic, Stochastic

Baseflow Total Suspended Solids Serial Correlation, 0, 0, 0, 0

Baseflow Total Phosphorus Mean (log mg/L), -0.82, -1.11, -1.11, -1.11

Baseflow Total Phosphorus Standard Deviation (log mg/L), 0.19, 0.48, 0.48, 0.48

Baseflow Total Phosphorus Estimation

Method, Stochastic, Stochastic, Stochastic, Stochastic

Baseflow Total Phosphorus Serial Correlation, 0, 0, 0, 0

Baseflow Total Nitrogen Mean (log mg/L), 0.32, 0.14, 0.14, 0.14

Baseflow Total Nitrogen Standard Deviation (log mg/L), 0.12, 0.2, 0.2, 0.2

Baseflow Total Nitrogen Estimation

Method, Stochastic, Stochastic, Stochastic, Stochastic

Baseflow Total Nitrogen Serial Correlation, 0, 0, 0, 0

Flow based constituent generation - enabled, Off, Off, Off, Off

Flow based constituent generation - flow file, , , ,

Flow based constituent generation - base flow column, , , ,

Flow based constituent generation - pervious flow column, , , ,

Flow based constituent generation - impervious flow column, , , ,

Flow based constituent generation - unit, , , ,
 OUT - Mean Annual Flow (ML/yr), 2.07, 2.87, 3.60, 6.57
 OUT - TSS Mean Annual Load (kg/yr), 65.9, 1.32E3, 1.54E3, 843
 OUT - TP Mean Annual Load (kg/yr), 0.379, 2.06, 2.62, 2.46
 OUT - TN Mean Annual Load (kg/yr), 4.84, 6.56, 8.27, 15.2
 OUT - Gross Pollutant Mean Annual Load (kg/yr), 57.8, 81.2, 101, 0.00
 Rain In (ML/yr), 2.31881, 3.43777, 4.04444, 17.2967
 ET Loss (ML/yr), 0.252606, 0.567758, 0.440598, 10.7236
 Deep Seepage Loss (ML/yr), 0, 0, 0, 0
 Baseflow Out (ML/yr), 0, 0, 0, 0
 Imp. Stormflow Out (ML/yr), 2.06621, 2.72631, 3.60385, 0
 Perv. Stormflow Out (ML/yr), 0, 0.143729, 0, 6.57412
 Total Stormflow Out (ML/yr), 2.06621, 2.87004, 3.60385, 6.57412
 Total Outflow (ML/yr), 2.06621, 2.87004, 3.60385, 6.57412
 Change in Soil Storage (ML/yr), 0, -2.06173E-5, 0, -0.000944641
 TSS Baseflow Out (kg/yr), 0, 0, 0, 0
 TSS Total Stormflow Out (kg/yr), 65.9288, 1320.5, 1543.61, 843.374
 TSS Total Outflow (kg/yr), 65.9288, 1320.5, 1543.61, 843.374
 TP Baseflow Out (kg/yr), 0, 0, 0, 0
 TP Total Stormflow Out (kg/yr), 0.379142, 2.05917, 2.61548, 2.46474
 TP Total Outflow (kg/yr), 0.379142, 2.05917, 2.61548, 2.46474
 TN Baseflow Out (kg/yr), 0, 0, 0, 0
 TN Total Stormflow Out (kg/yr), 4.84117, 6.56417, 8.27004, 15.2057
 TN Total Outflow (kg/yr), 4.84117, 6.56417, 8.27004, 15.2057
 GP Total Outflow (kg/yr), 57.8183, 81.2363, 100.846, 0

No Imported Data Source nodes

USTM treatment nodes

Location, Swale, Pond, Buffer Gravel, Buffer Sealed, Bioretention
 ID, 5, 6, 8, 9, 10
 Node Type, SwaleNode, PondNode, BufferNode, BufferNode, BioRetentionNodeV4
 Lo-flow bypass rate (cum/sec), 0, 0, , , 0
 Hi-flow bypass rate (cum/sec), , 100, , , 100
 Inlet pond volume, , 0, , ,
 Area (sqm), , 450, 2280.91791044776, 2988.69402985075, 100
 Initial Volume (m³), , 135, , ,
 Extended detention depth (m), 0.4, 0.4, , , 0.15
 Number of Rainwater tanks, , , , ,
 Permanent Pool Volume (cubic metres), , 135, , ,
 Proportion vegetated, , 0.1, , ,
 Equivalent Pipe Diameter (mm), , 300, , ,
 Overflow weir width (m), , 2, , , 1
 Notional Detention Time (hrs), , 0.377, , ,
 Orifice Discharge Coefficient, , 0.6, , ,
 Weir Coefficient, , 1.7, , , 1.7
 Number of CSTR Cells, 10, 2, , , 3
 Total Suspended Solids - k (m/yr), 8000, 400, , , 8000
 Total Suspended Solids - C* (mg/L), 20, 12, , , 20
 Total Suspended Solids - C** (mg/L), 14, 12, , ,
 Total Phosphorus - k (m/yr), 6000, 300, , , 6000
 Total Phosphorus - C* (mg/L), 0.13, 0.09, , , 0.13
 Total Phosphorus - C** (mg/L), 0.13, 0.09, , ,
 Total Nitrogen - k (m/yr), 500, 40, , , 500
 Total Nitrogen - C* (mg/L), 1.4, 1, , , 1.4
 Total Nitrogen - C** (mg/L), 1.4, 1, , ,
 Threshold Hydraulic Loading for C** (m/yr), 3500, 3500, , ,
 Horizontal Flow Coefficient, , , , , 3

Reuse Enabled,Off,On,Off,Off,Off
 Max drawdown height (m), ,0.3, , ,
 Annual Demand Enabled,Off,On,Off,Off,Off
 Annual Demand Value (ML/year), ,5.475, , ,
 Annual Demand Distribution, ,PETSubRain, , ,
 Annual Demand Monthly Distribution: Jan, , , , ,
 Annual Demand Monthly Distribution: Feb, , , , ,
 Annual Demand Monthly Distribution: Mar, , , , ,
 Annual Demand Monthly Distribution: Apr, , , , ,
 Annual Demand Monthly Distribution: May, , , , ,
 Annual Demand Monthly Distribution: Jun, , , , ,
 Annual Demand Monthly Distribution: Jul, , , , ,
 Annual Demand Monthly Distribution: Aug, , , , ,
 Annual Demand Monthly Distribution: Sep, , , , ,
 Annual Demand Monthly Distribution: Oct, , , , ,
 Annual Demand Monthly Distribution: Nov, , , , ,
 Annual Demand Monthly Distribution: Dec, , , , ,
 Daily Demand Enabled,Off,Off,Off,Off,Off
 Daily Demand Value (ML/day), , , , ,
 Custom Demand Enabled,Off,Off,Off,Off,Off
 Custom Demand Time Series File, , , , ,
 Custom Demand Time Series Units, , , , ,
 Filter area (sqm), , , , ,80
 Filter perimeter (m), , , , ,102
 Filter depth (m), , , , ,0.4
 Filter Median Particle Diameter (mm), , , , ,
 Saturated Hydraulic Conductivity (mm/hr), , , , ,200
 Infiltration Media Porosity, , , , ,0.35
 Length (m),150, , , ,
 Bed slope,0.01, , , ,
 Base Width (m),2, , , ,
 Top width (m),6, , , ,
 Vegetation height (m),0.1, , , ,
 Vegetation Type, , , , ,Vegetated with Effective Nutrient Removal Plants
 Total Nitrogen Content in Filter (mg/kg), , , , ,400
 Orthophosphate Content in Filter (mg/kg), , , , ,30
 Is Base Lined?, , , , ,No
 Is Underdrain Present?, , , , ,Yes
 Is Submerged Zone Present?, , , , ,No
 Submerged Zone Depth (m), , , , ,
 B for Media Soil Texture,-9999,-9999,-9999,-9999,13
 Proportion of upstream impervious area treated, , ,1,1,
 Exfiltration Rate (mm/hr),0.2,0.2,0.2,0.2,0.2
 Evaporative Loss as % of PET, ,100, , ,100
 Depth in metres below the drain pipe, , , , ,
 TSS A Coefficient, , , , ,
 TSS B Coefficient, , , , ,
 TP A Coefficient, , , , ,
 TP B Coefficient, , , , ,
 TN A Coefficient, , , , ,
 TN B Coefficient, , , , ,
 Sfc, , , , ,0.61
 S*, , , , ,0.37
 Sw, , , , ,0.11
 Sh, , , , ,0.05
 Emax (m/day), , , , ,0.008
 Ew (m/day), , , , ,0.001
 IN - Mean Annual Flow (ML/yr),14.8,14.6,2.87,3.60,14.8

IN - TSS Mean Annual Load (kg/yr), 1.67E3, 388, 1.32E3, 1.54E3, 507
 IN - TP Mean Annual Load (kg/yr), 5.23, 1.99, 2.06, 2.62, 2.72
 IN - TN Mean Annual Load (kg/yr), 30.9, 21.9, 6.56, 8.27, 27.8
 IN - Gross Pollutant Mean Annual Load (kg/yr), 228, 0.00, 81.2, 101, 0.00
 OUT - Mean Annual Flow (ML/yr), 14.8, 12.0, 2.74, 3.43, 14.6
 OUT - TSS Mean Annual Load (kg/yr), 507, 346, 351, 406, 388
 OUT - TP Mean Annual Load (kg/yr), 2.72, 1.81, 1.05, 1.34, 1.99
 OUT - TN Mean Annual Load (kg/yr), 27.8, 19.2, 4.82, 6.06, 21.9
 OUT - Gross Pollutant Mean Annual Load (kg/yr), 0.00, 0.00, 76.1, 94.4, 0.00
 Flow In (ML/yr), 14.809, 14.57, 2.87042, 3.60383, 14.7571
 ET Loss (ML/yr), 0, 0, 0.273472, 0, 0, 0.150425
 Infiltration Loss (ML/yr), 0.0739918, 0.333992, 0.131902, 0.172487, 0.0337664
 Low Flow Bypass Out (ML/yr), 0, 0, 0, 0, 0
 High Flow Bypass Out (ML/yr), 0, 0, 0, 0, 0
 Orifice / Filter Out (ML/yr), 14.6549, 10.336, 2.73822, 3.43156, 5.12584
 Weir Out (ML/yr), 0.102268, 1.70398, 0, 0, 9.44752
 Transfer Function Out (ML/yr), 0, 0, 0, 0, 0
 Reuse Supplied (ML/yr), 0, 1.93925, 0, 0, 0
 Reuse Requested (ML/yr), 0, 5.48133, 0, 0, 0
 % Reuse Demand Met, 0, 35.3792, 0, 0, 0
 % Load Reduction, 0.350598, 17.3641, 4.60539, 4.78025, 1.24522
 TSS Flow In (kg/yr), 1666.42, 388.227, 1320.5, 1543.61, 507.256
 TSS ET Loss (kg/yr), 0, 0, 0, 0, 0
 TSS Infiltration Loss (kg/yr), 1.17401, 4.12748, 0, 0, 0.138426
 TSS Low Flow Bypass Out (kg/yr), 0, 0, 0, 0, 0
 TSS High Flow Bypass Out (kg/yr), 0, 0, 0, 0, 0
 TSS Orifice / Filter Out (kg/yr), 493.922, 257.749, 350.97, 406.143, 15.3
 TSS Weir Out (kg/yr), 13.408, 87.7664, 0, 0, 372.924
 TSS Transfer Function Out (kg/yr), 0, 0, 0, 0, 0
 TSS Reuse Supplied (kg/yr), 0, 23.4847, 0, 0, 0
 TSS Reuse Requested (kg/yr), 0, 0, 0, 0, 0
 TSS % Reuse Demand Met, 0, 0, 0, 0, 0
 TSS % Load Reduction, 69.5556, 11.0015, 73.4215, 73.6887, 23.4659
 TP Flow In (kg/yr), 5.23199, 1.98591, 2.05918, 2.61548, 2.72415
 TP ET Loss (kg/yr), 0, 0, 0, 0, 0
 TP Infiltration Loss (kg/yr), 0.0100738, 0.0305113, 0, 0, 0.00108638
 TP Low Flow Bypass Out (kg/yr), 0, 0, 0, 0, 0
 TP High Flow Bypass Out (kg/yr), 0, 0, 0, 0, 0
 TP Orifice / Filter Out (kg/yr), 2.68311, 1.41606, 1.05221, 1.33589, 0.135205
 TP Weir Out (kg/yr), 0.0413352, 0.390371, 0, 0, 1.85068
 TP Transfer Function Out (kg/yr), 0, 0, 0, 0, 0
 TP Reuse Supplied (kg/yr), 0, 0.175717, 0, 0, 0
 TP Reuse Requested (kg/yr), 0, 0, 0, 0, 0
 TP % Reuse Demand Met, 0, 0, 0, 0, 0
 TP % Load Reduction, 47.9272, 9.0375, 48.9013, 48.9237, 27.1005
 TN Flow In (kg/yr), 30.9316, 21.8959, 6.56417, 8.27004, 27.7598
 TN ET Loss (kg/yr), 0, 0, 0, 0, 0
 TN Infiltration Loss (kg/yr), 0.112372, 0.34697, 0, 0, 0.0232906
 TN Low Flow Bypass Out (kg/yr), 0, 0, 0, 0, 0
 TN High Flow Bypass Out (kg/yr), 0, 0, 0, 0, 0
 TN Orifice / Filter Out (kg/yr), 27.582, 15.9614, 4.81981, 6.06489, 3.40855
 TN Weir Out (kg/yr), 0.181537, 3.20427, 0, 0, 18.4866
 TN Transfer Function Out (kg/yr), 0, 0, 0, 0, 0
 TN Reuse Supplied (kg/yr), 0, 2.0278, 0, 0, 0
 TN Reuse Requested (kg/yr), 0, 0, 0, 0, 0
 TN % Reuse Demand Met, 0, 0, 0, 0, 0
 TN % Load Reduction, 10.2421, 12.469, 26.5739, 26.6644, 21.1263
 GP Flow In (kg/yr), 228.379, 0, 81.2366, 100.846, 0

GP ET Loss (kg/yr),0,0,0,0,0
 GP Infiltration Loss (kg/yr),0,0,0,0,0
 GP Low Flow Bypass Out (kg/yr),0,0,0,0,0
 GP High Flow Bypass Out (kg/yr),0,0,0,0,0
 GP Orifice / Filter Out (kg/yr),0,0,0,0,0
 GP Weir Out (kg/yr),0,0,0,0,0
 GP Transfer Function Out (kg/yr),0,0,0,0,0
 GP Reuse Supplied (kg/yr),0,0,0,0,0
 GP Reuse Requested (kg/yr),0,0,0,0,0
 GP % Reuse Demand Met,0,0,0,0,0
 GP % Load Reduction,100,100,100,100,100
 PET Scaling Factor, , , , ,2.1

No Generic treatment nodes

Other nodes

Location,Corcoran Road

ID,1

Node Type,ReceivingNode

IN - Mean Annual Flow (ML/yr),12.0

IN - TSS Mean Annual Load (kg/yr),346

IN - TP Mean Annual Load (kg/yr),1.81

IN - TN Mean Annual Load (kg/yr),19.2

IN - Gross Pollutant Mean Annual Load (kg/yr),0.00

OUT - Mean Annual Flow (ML/yr),12.0

OUT - TSS Mean Annual Load (kg/yr),346

OUT - TP Mean Annual Load (kg/yr),1.81

OUT - TN Mean Annual Load (kg/yr),19.2

OUT - Gross Pollutant Mean Annual Load (kg/yr),0.00

% Load Reduction,20.3

TSS % Load Reduction,90.8

TN % Load Reduction,45.1

TP % Load Reduction,76.0

GP % Load Reduction,100

Links

Location,Drainage Link,Drainage Link,Drainage Link,Drainage Link,Drainage Link,Drainage Link,Drainage Link,Drainage Link,Drainage Link

Source node ID,6,3,4,2,7,9,8,5,10

Target node ID,1,8,9,5,5,5,5,10,6

Muskingum-Cunge Routing,Not Routed,Not Routed,Not Routed,Not Routed,Not Routed,Not Routed,Not Routed,Not Routed,Not Routed

Muskingum K, , , , , , , , ,

Muskingum theta, , , , , , , , ,

IN - Mean Annual Flow (ML/yr),12.0,2.87,3.60,2.07,6.57,3.43,2.74,14.8,14.6

IN - TSS Mean Annual Load (kg/yr),346,1.32E3,1.54E3,65.9,843,406,351,507,388

IN - TP Mean Annual Load

(kg/yr),1.81,2.06,2.62,0.379,2.46,1.34,1.05,2.72,1.99

IN - TN Mean Annual Load (kg/yr),19.2,6.56,8.27,4.84,15.2,6.06,4.82,27.8,21.9

IN - Gross Pollutant Mean Annual Load

(kg/yr),0.00,81.2,101,57.8,0.00,94.4,76.1,0.00,0.00

OUT - Mean Annual Flow (ML/yr),12.0,2.87,3.60,2.07,6.57,3.43,2.74,14.8,14.6

OUT - TSS Mean Annual Load (kg/yr),346,1.32E3,1.54E3,65.9,843,406,351,507,388

OUT - TP Mean Annual Load

(kg/yr),1.81,2.06,2.62,0.379,2.46,1.34,1.05,2.72,1.99

OUT - TN Mean Annual Load

(kg/yr),19.2,6.56,8.27,4.84,15.2,6.06,4.82,27.8,21.9

OUT - Gross Pollutant Mean Annual Load
(kg/yr), 0.00, 81.2, 101, 57.8, 0.00, 94.4, 76.1, 0.00, 0.00

Catchment Details

Catchment Name, Boonah Cranes Sandy Ck

Timestep, 6 Minutes

Start Date, 1/01/1997

End Date, 31/07/2010 11:54:00 PM

Rainfall Station, 40659 GREENBANK

ET Station, User-defined monthly PET

Mean Annual Rainfall (mm), 674

Mean Annual ET (mm), 1443